

# BIONICLE

LESOVIKK



8939



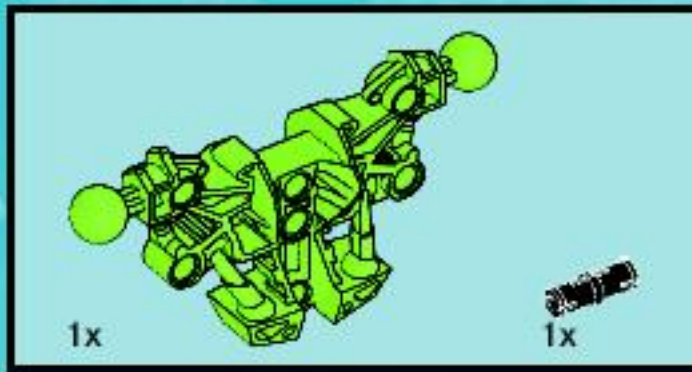

1

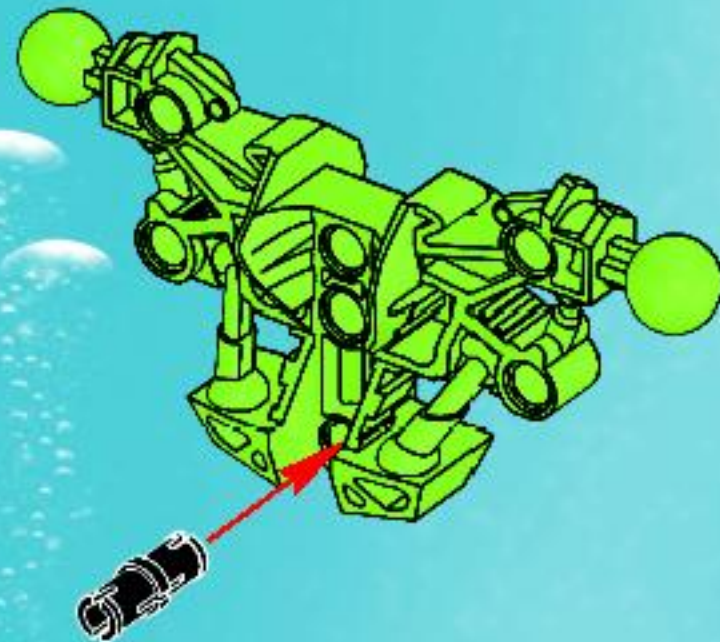
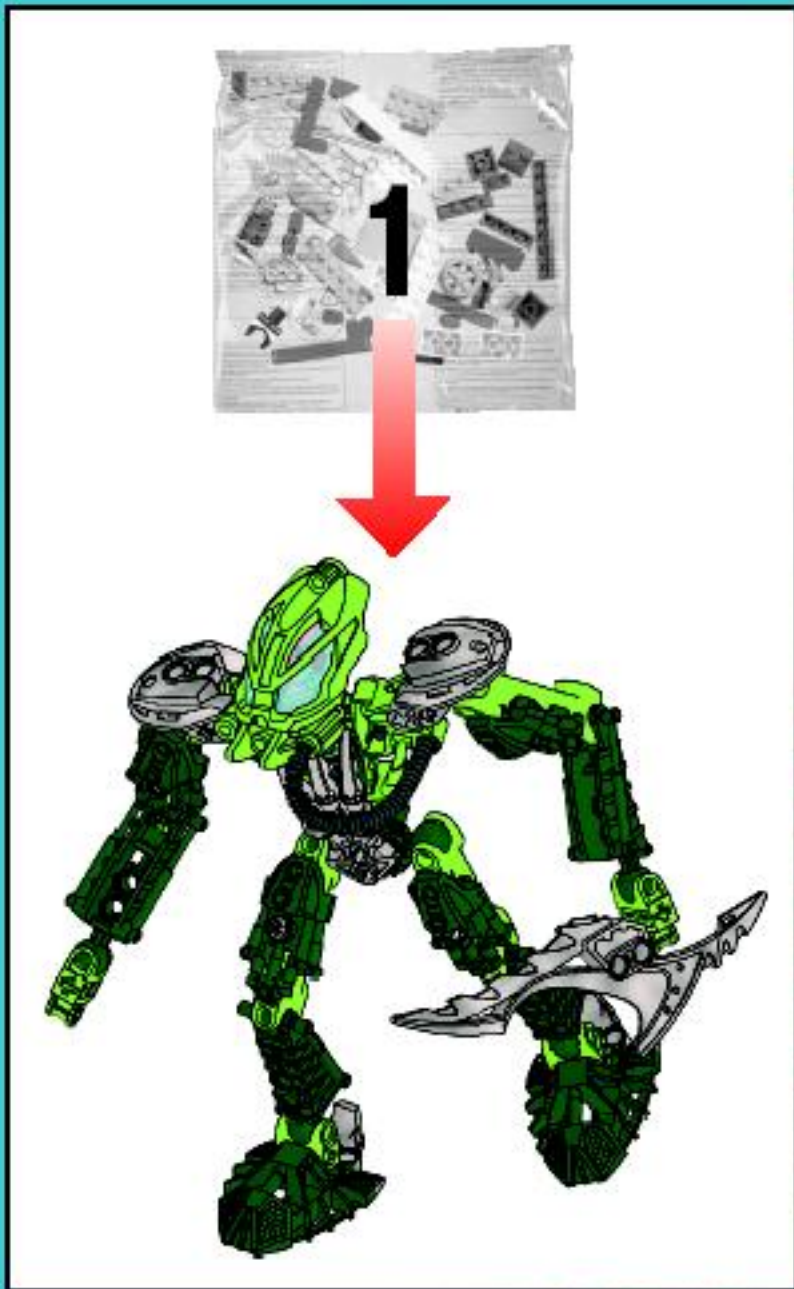



2

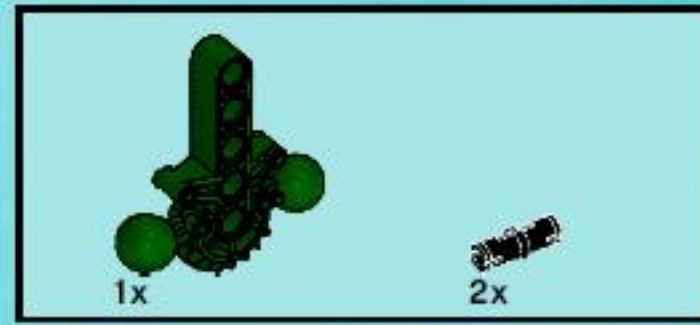
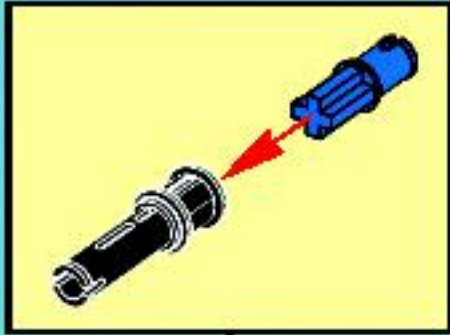

3







4

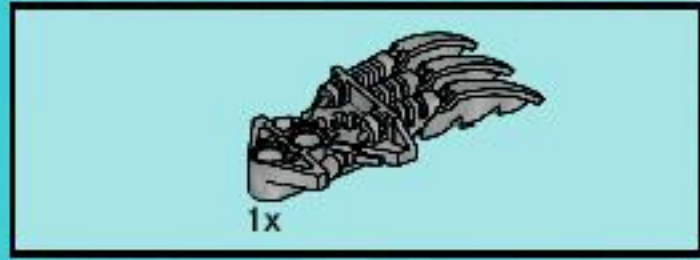
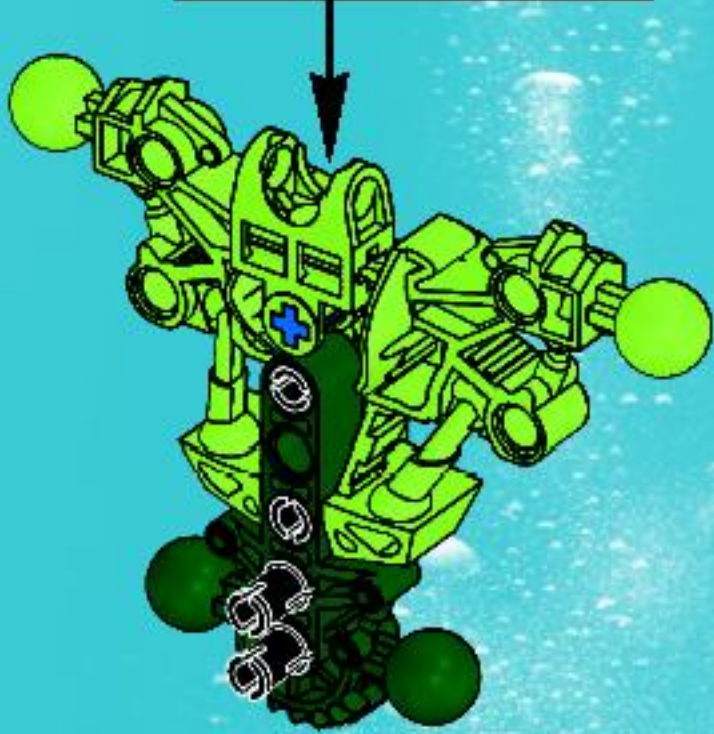
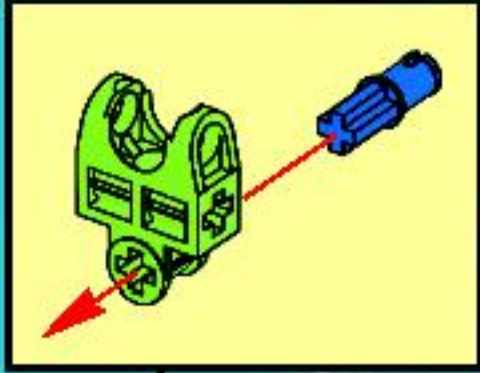

5

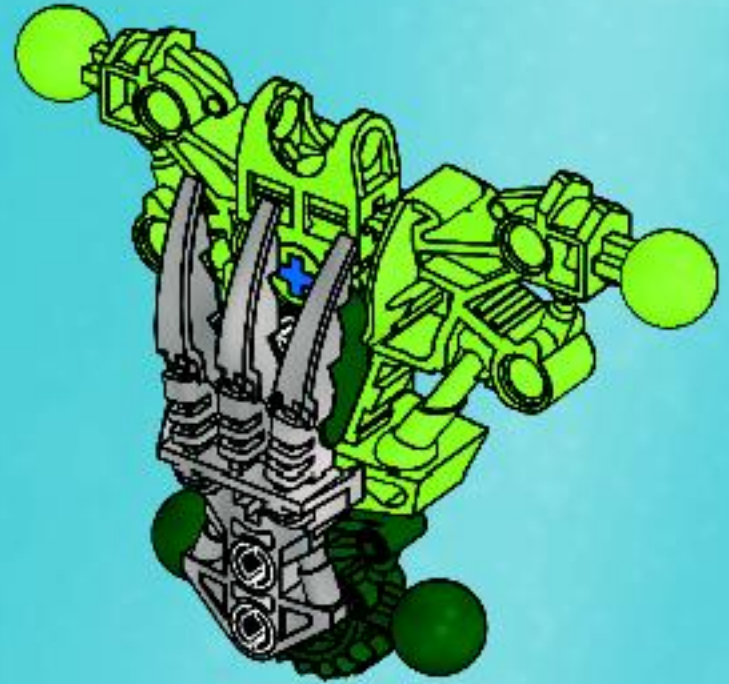

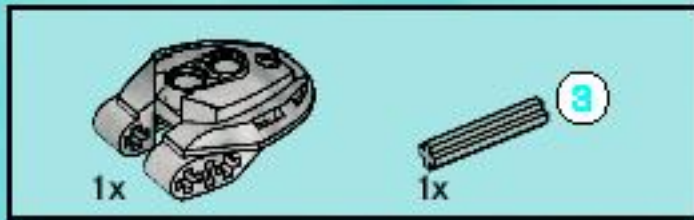

6

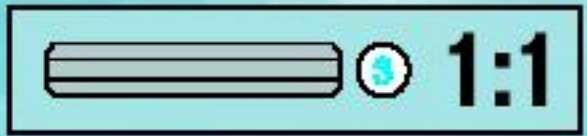
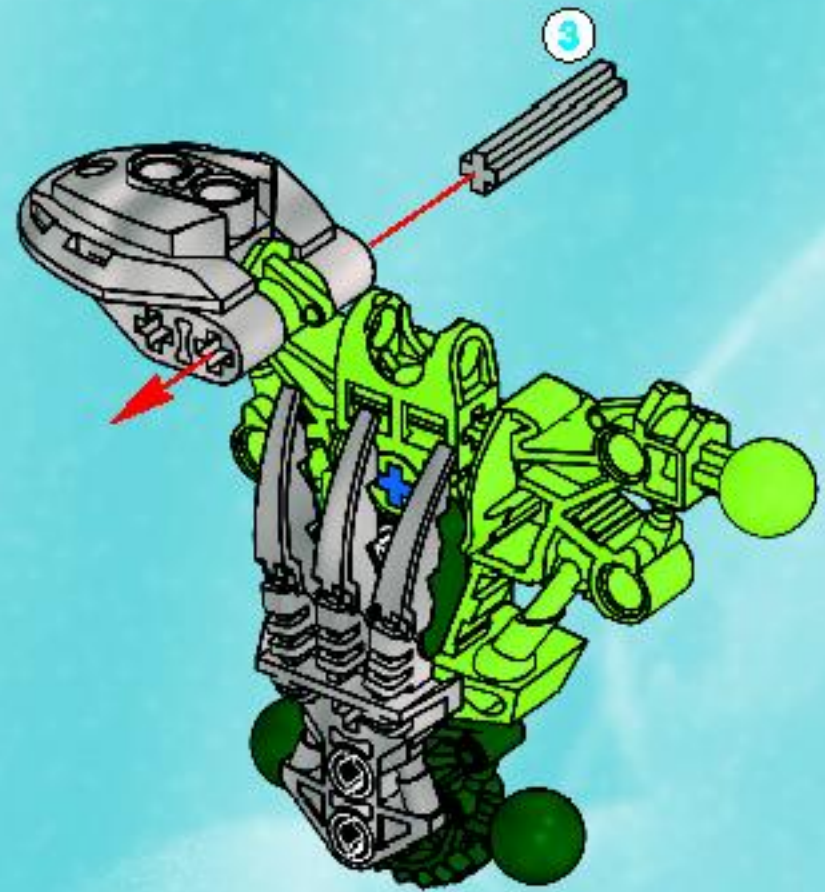

7

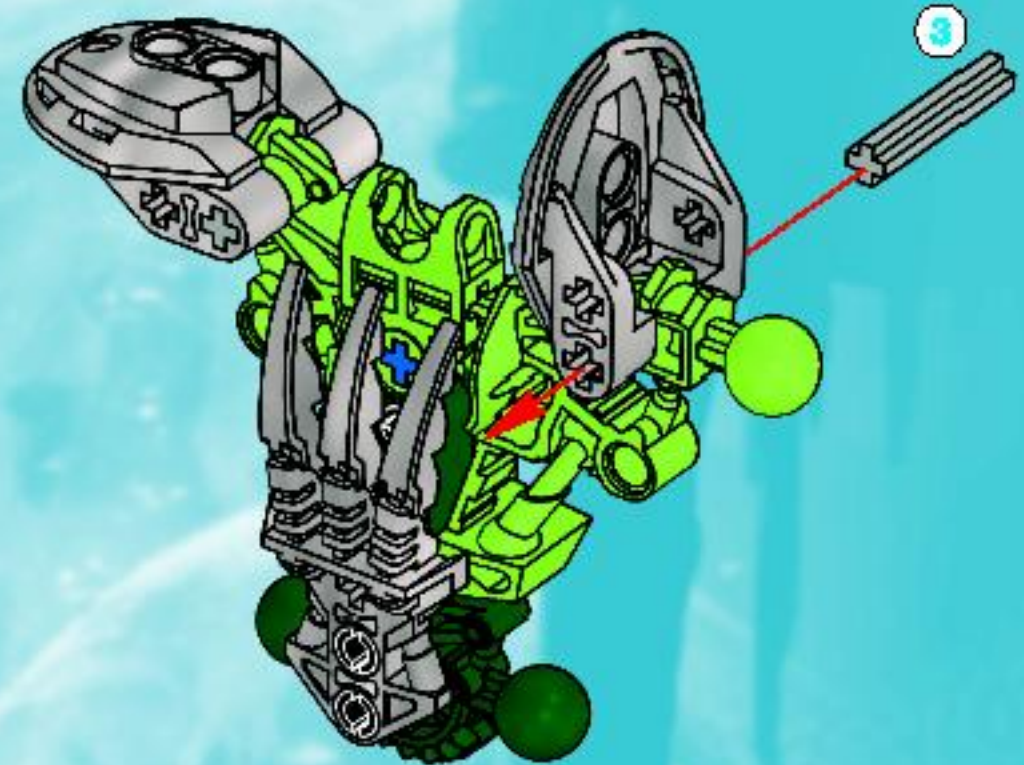



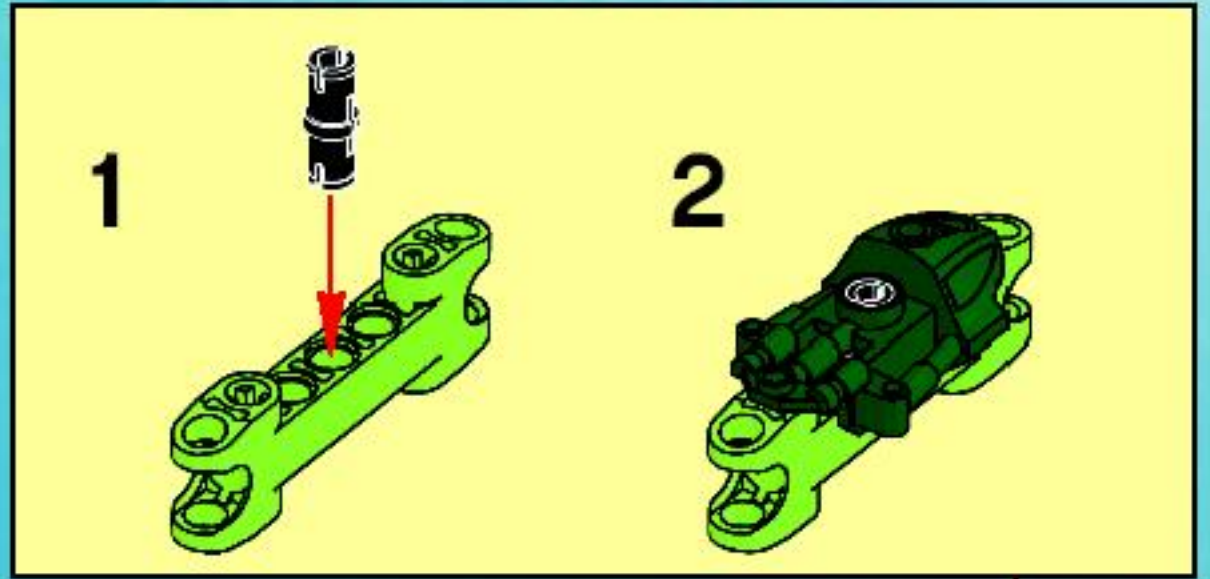
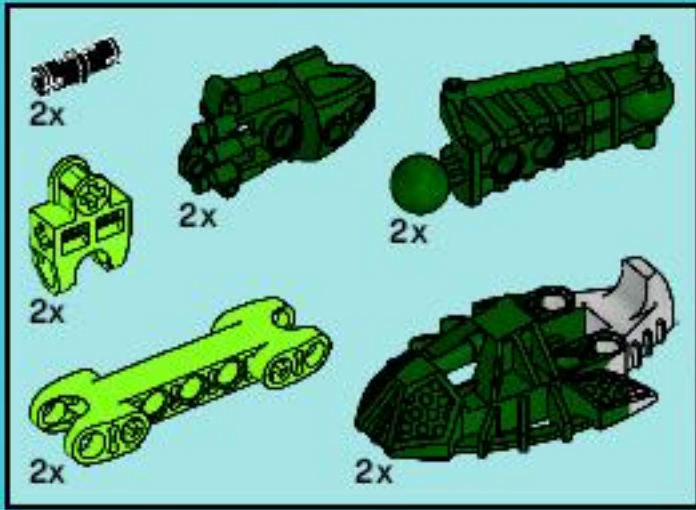

8

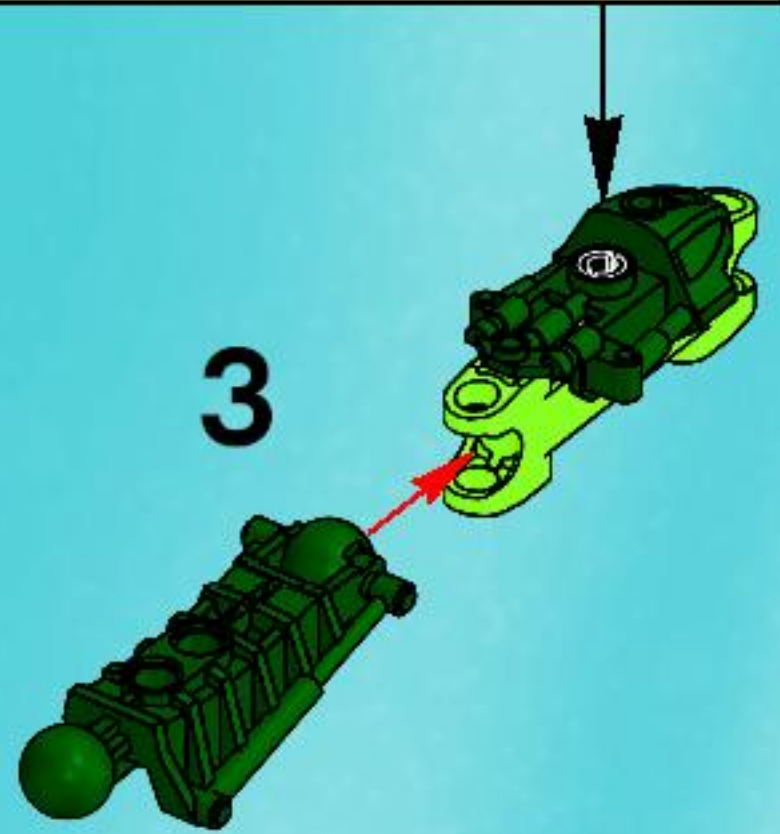
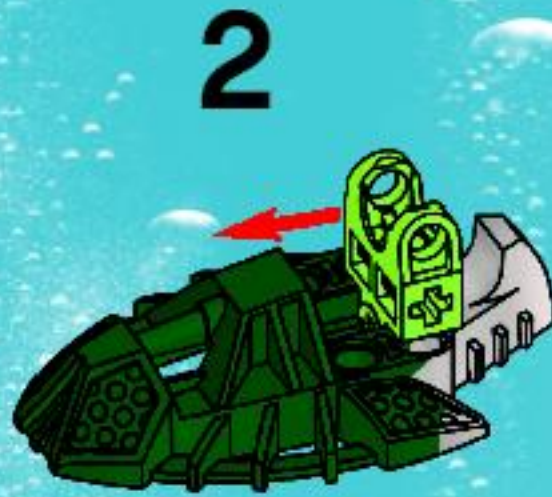
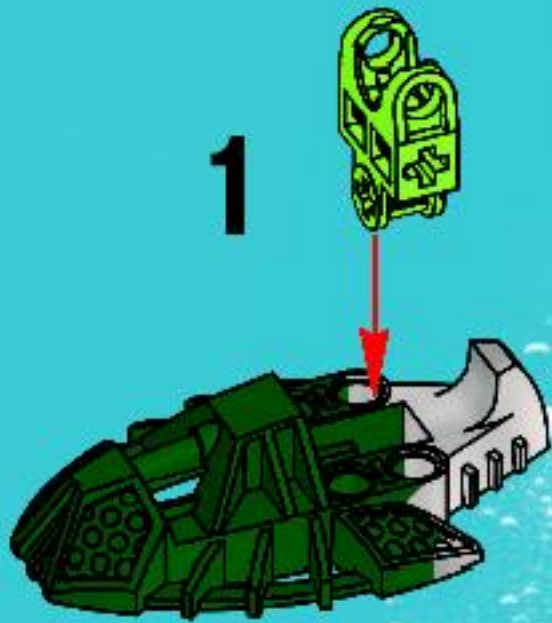



4

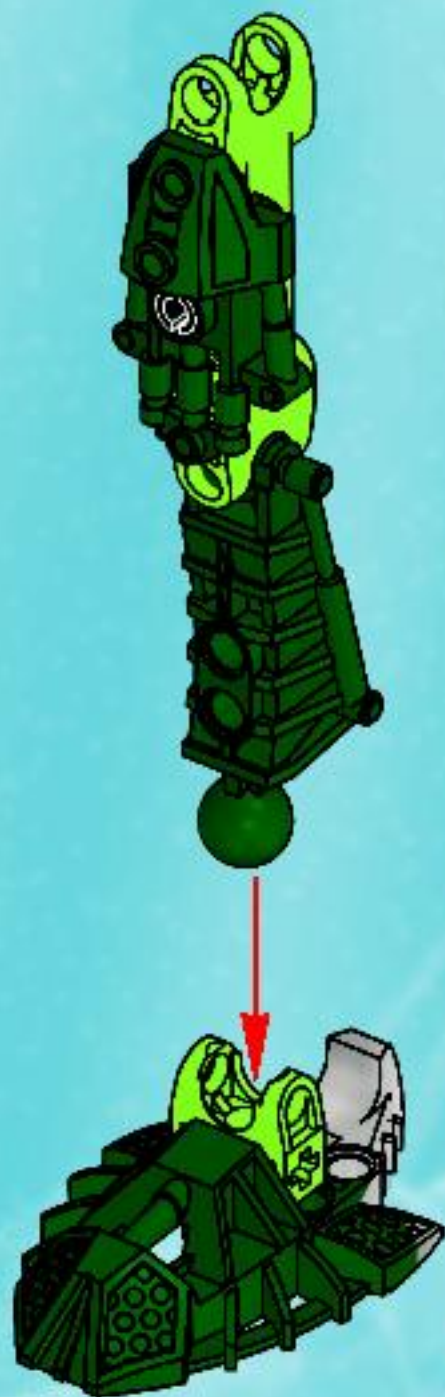

2x

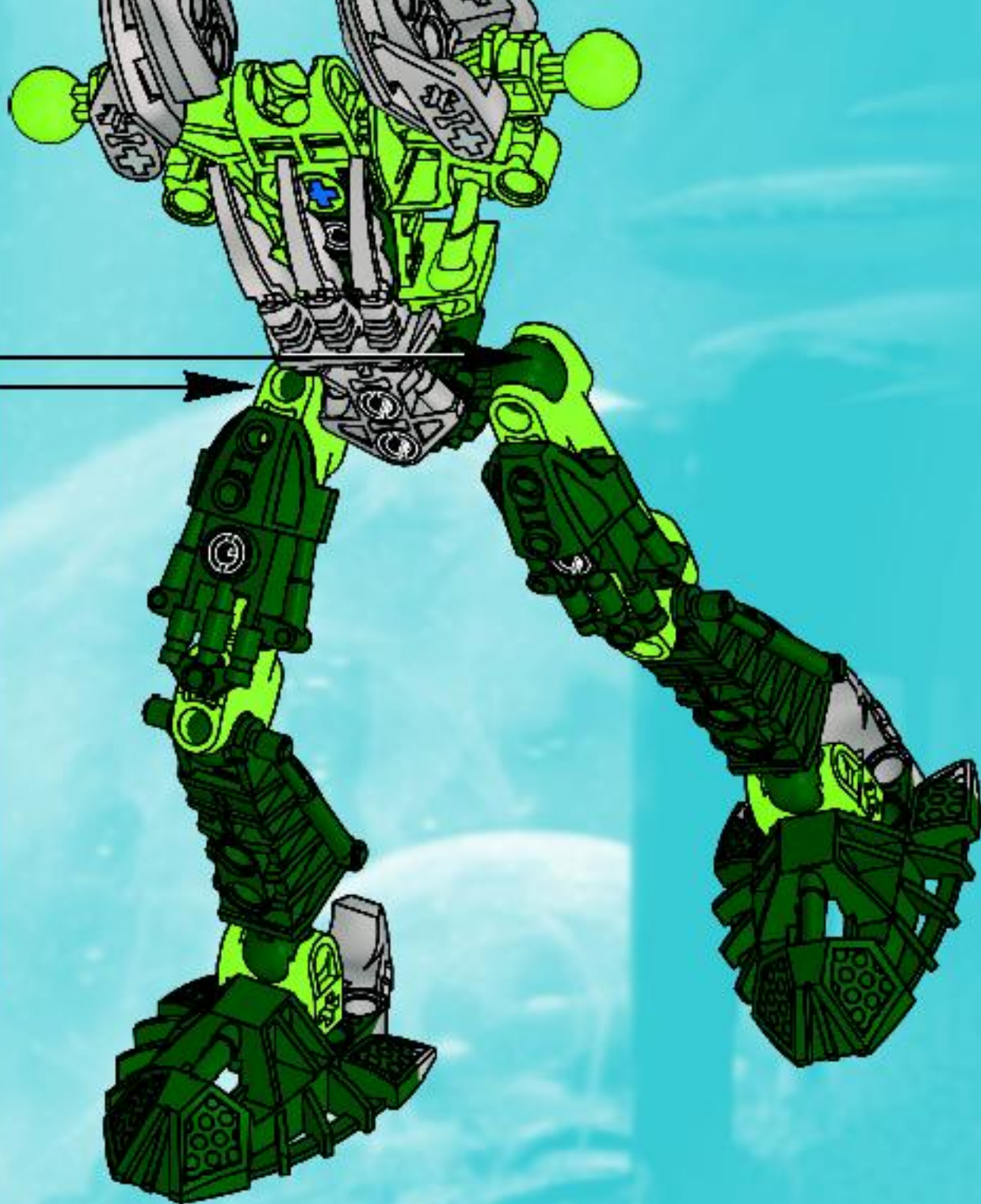

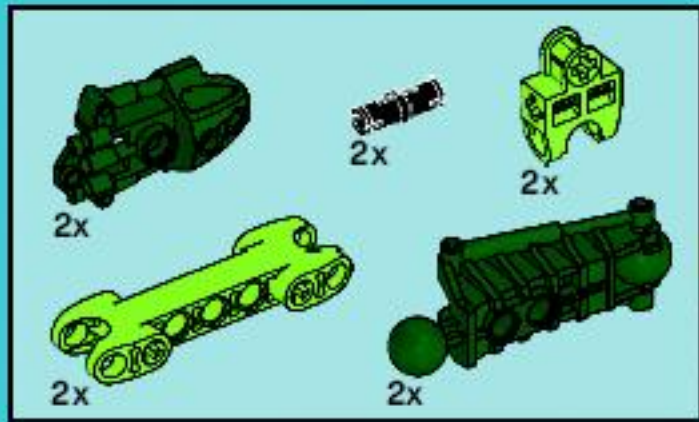

9

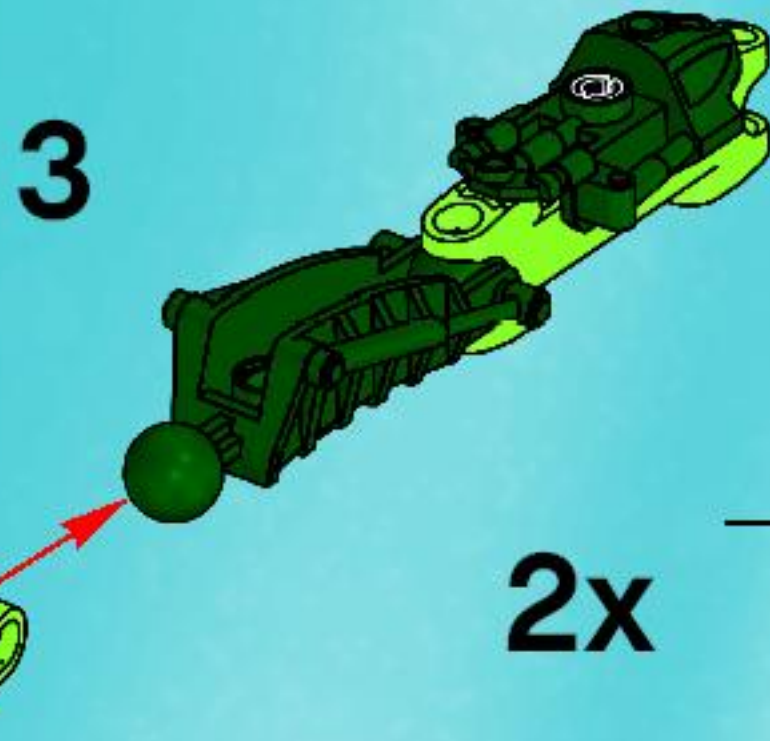
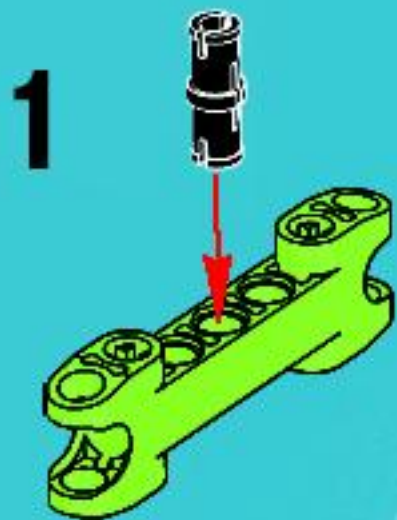



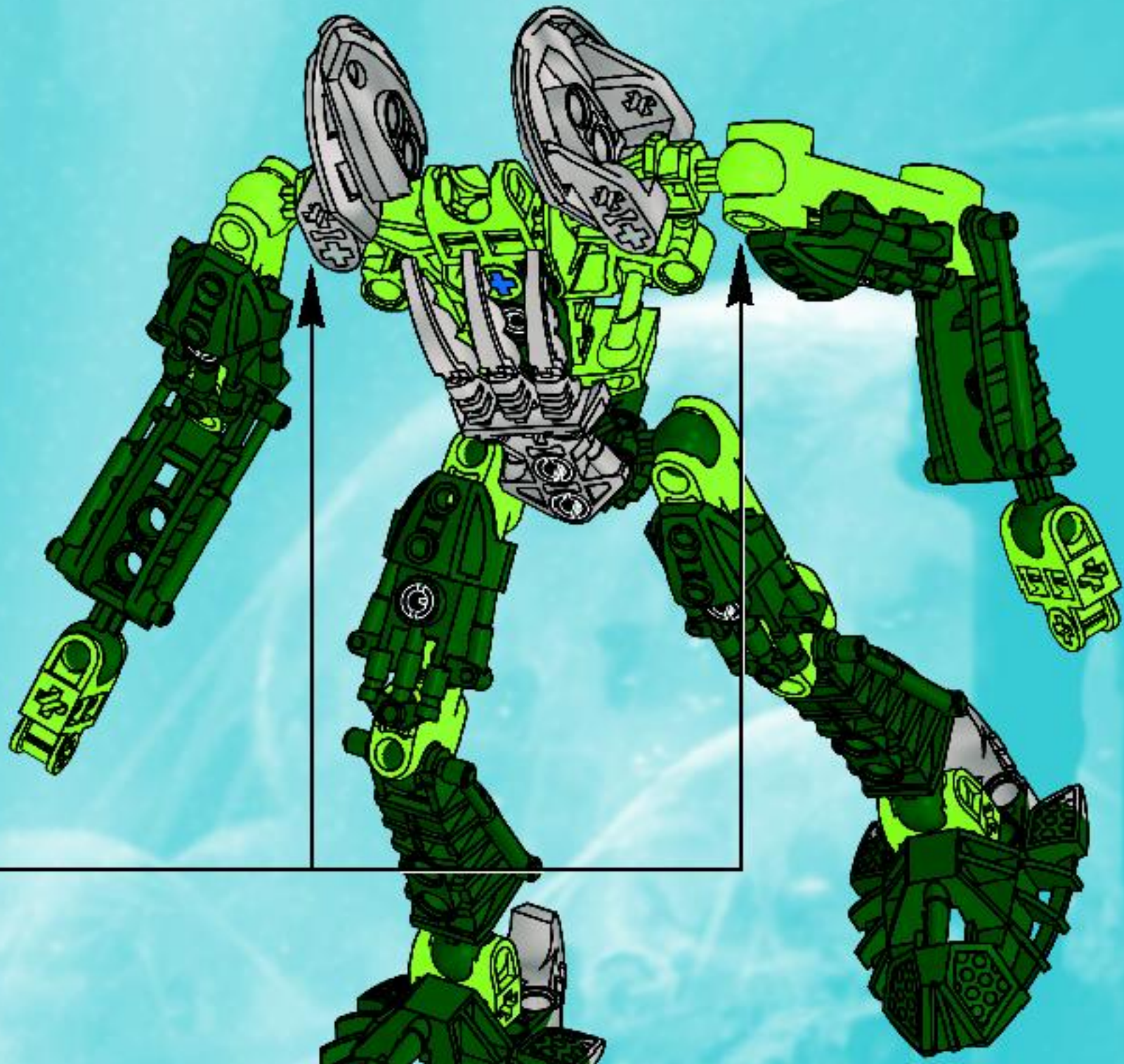



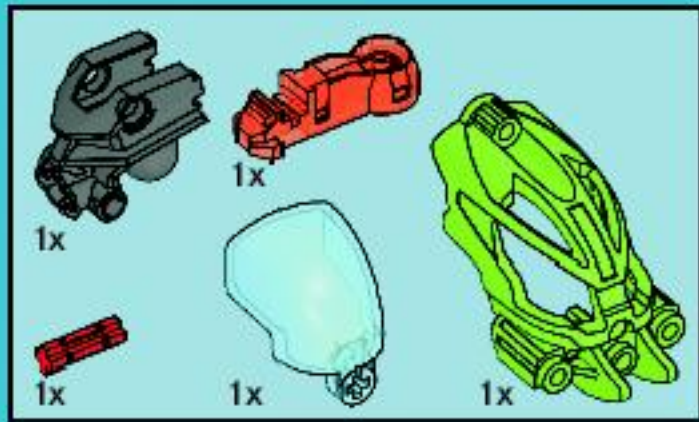

Battery is not replaceable  
La pile n'est pas remplaçable  
La batería no es reemplazable

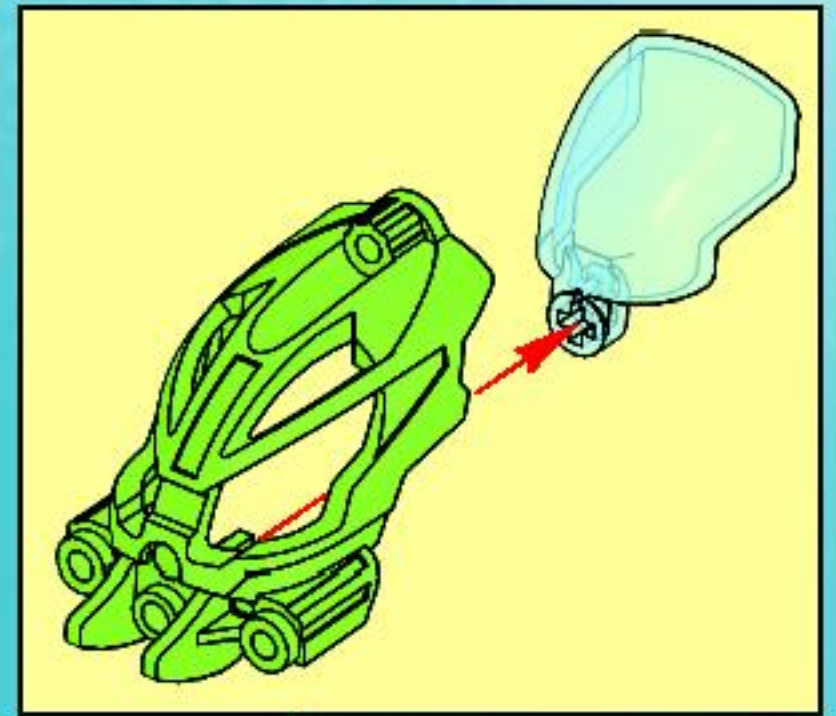

# 10

## 1

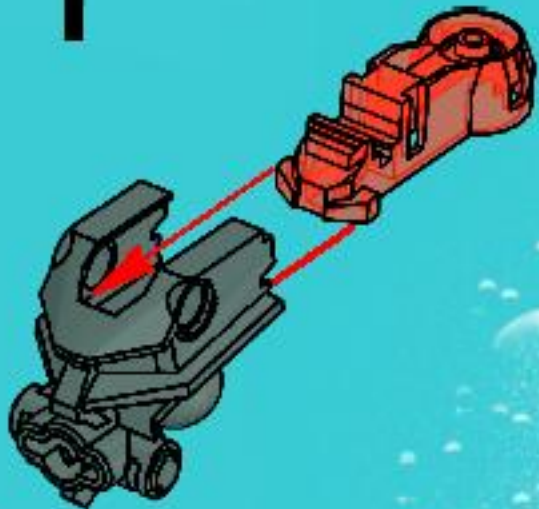

## 2

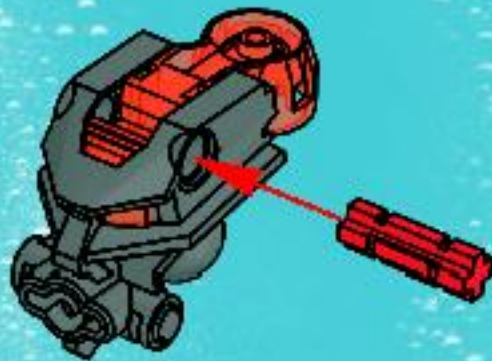

## 3

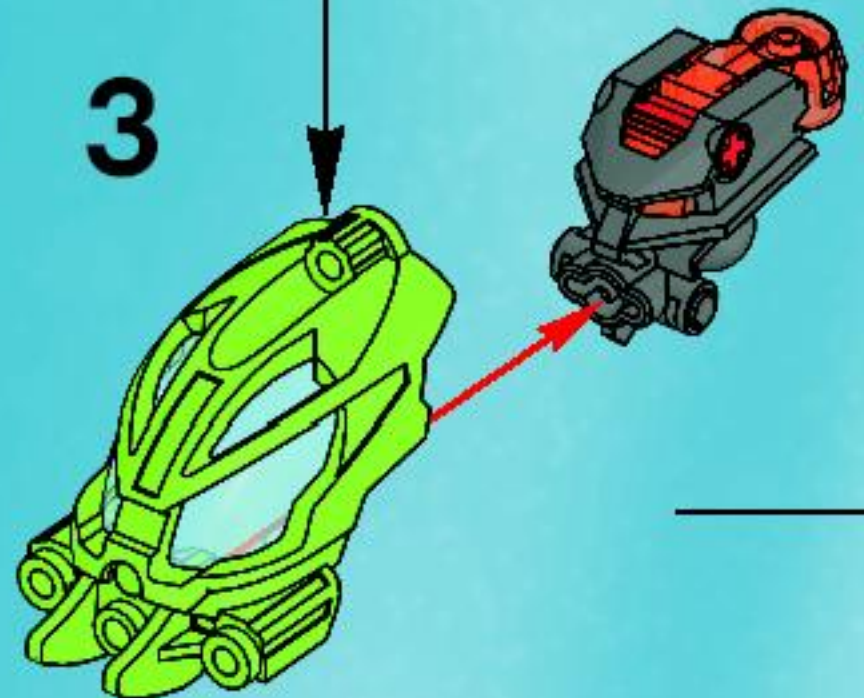



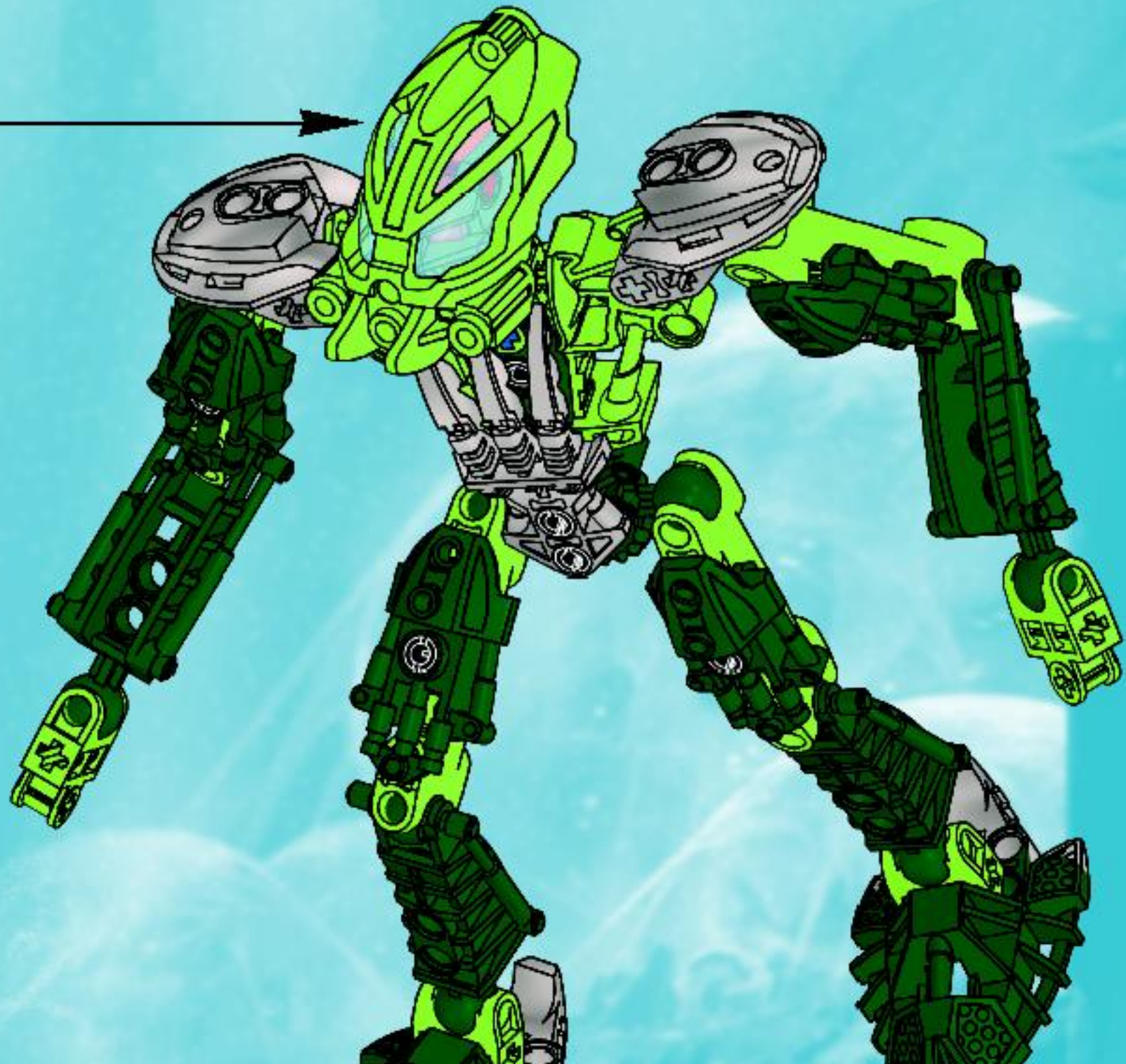



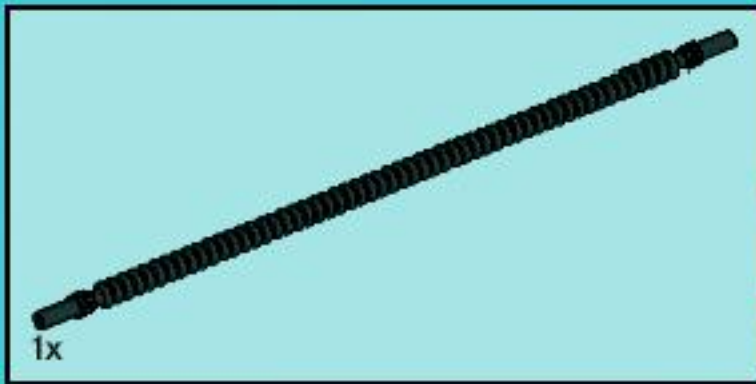

11





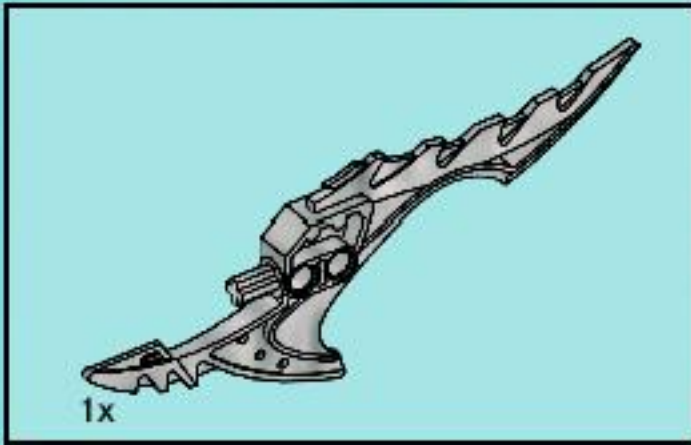

12

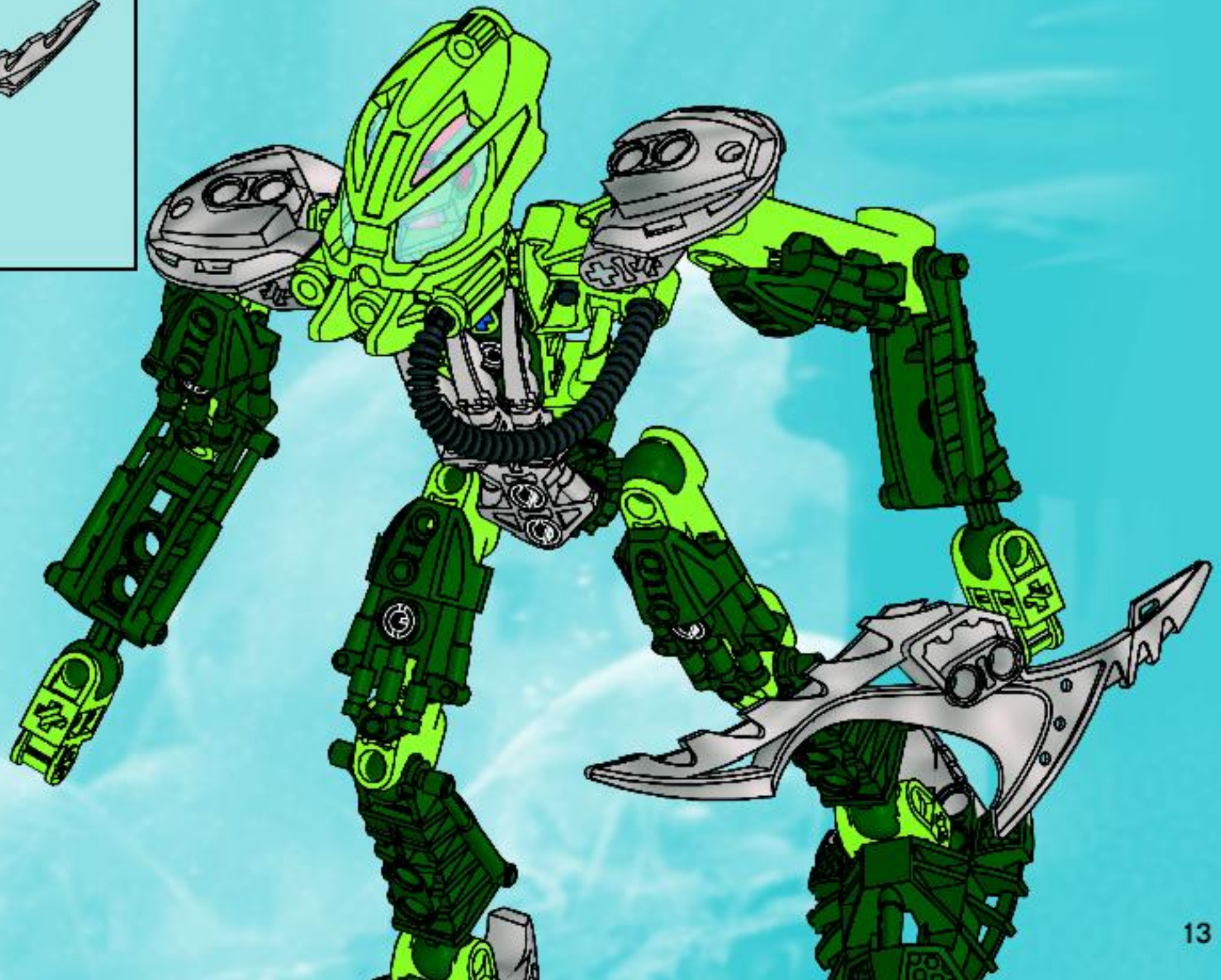



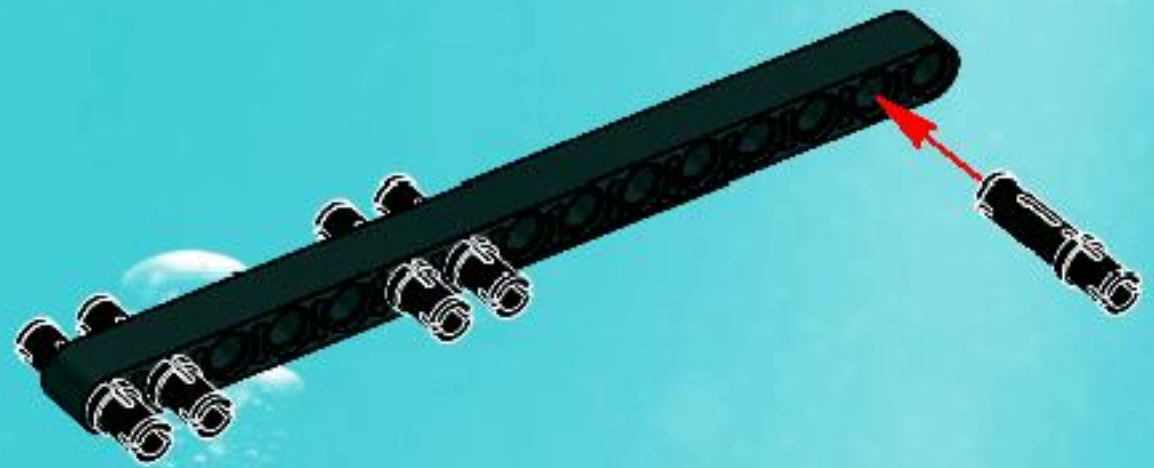
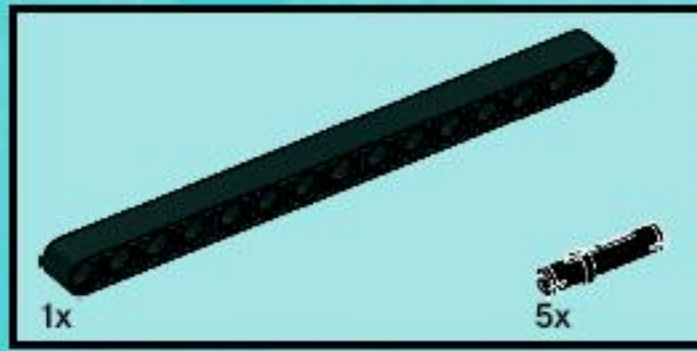
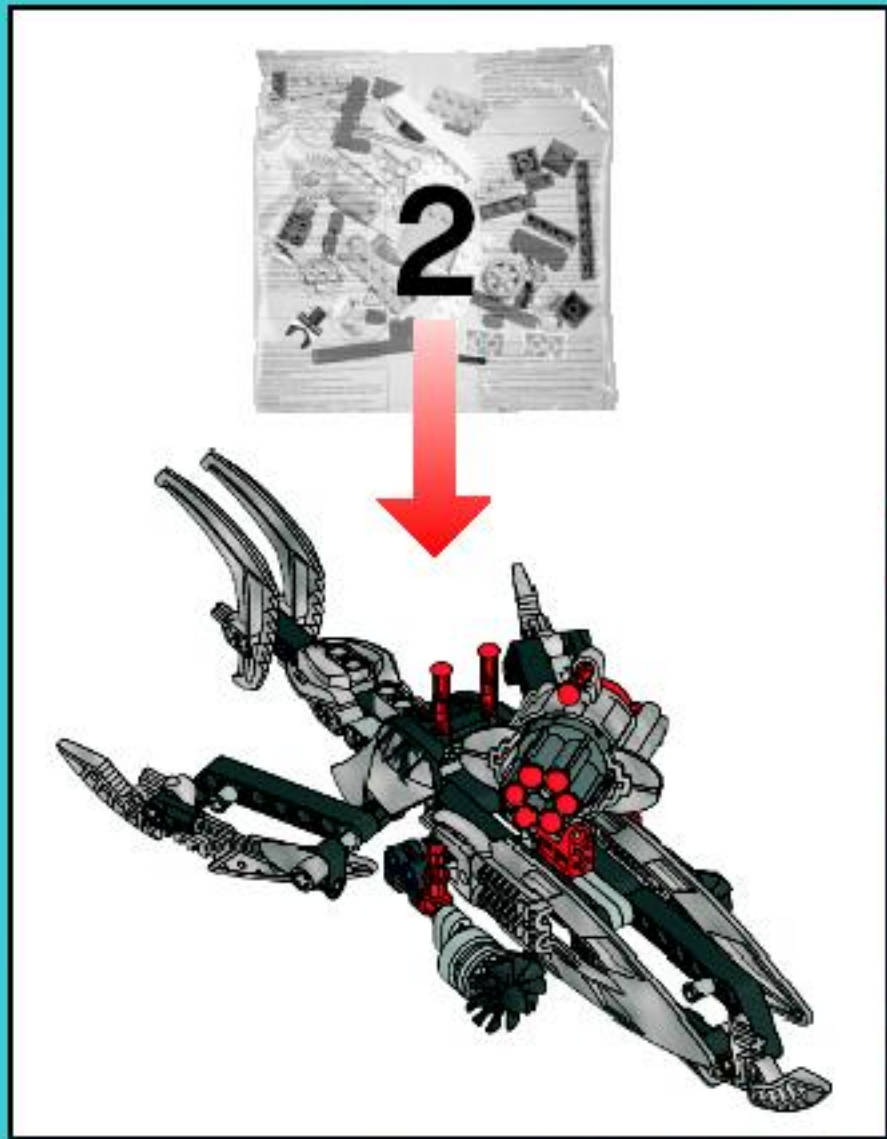



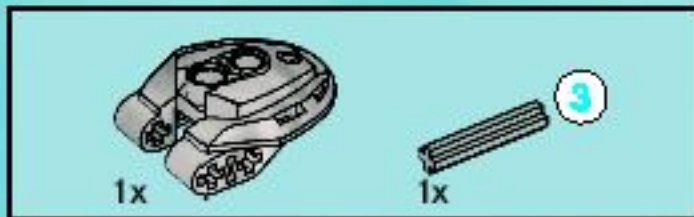

2

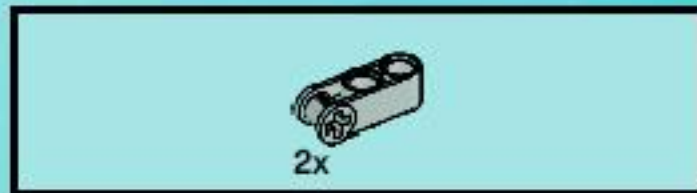
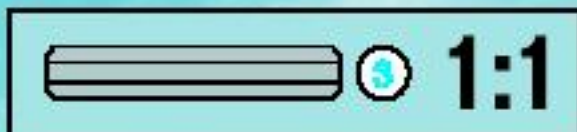
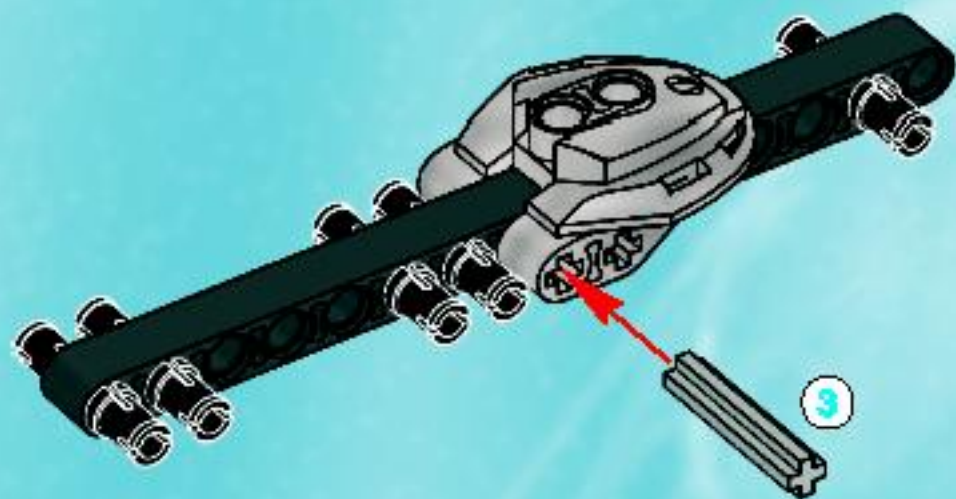

3

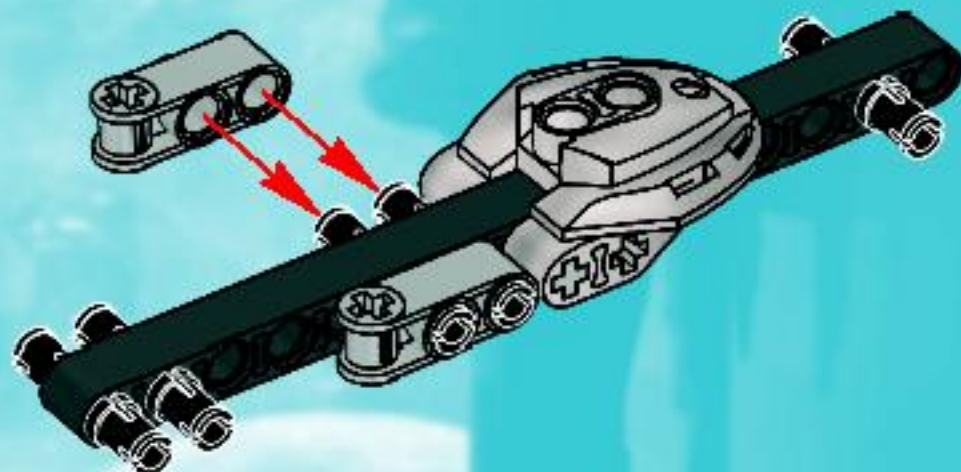





4

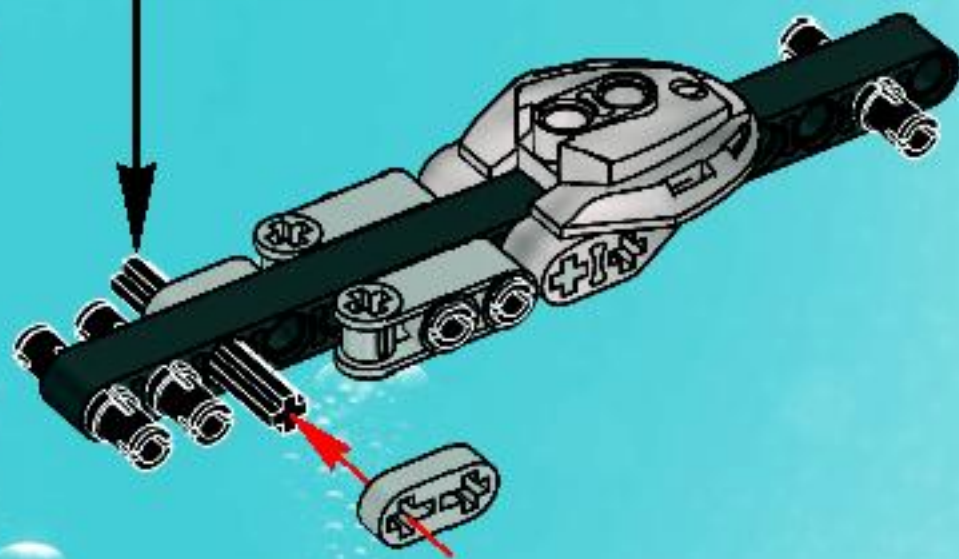





2x



1x

# 5

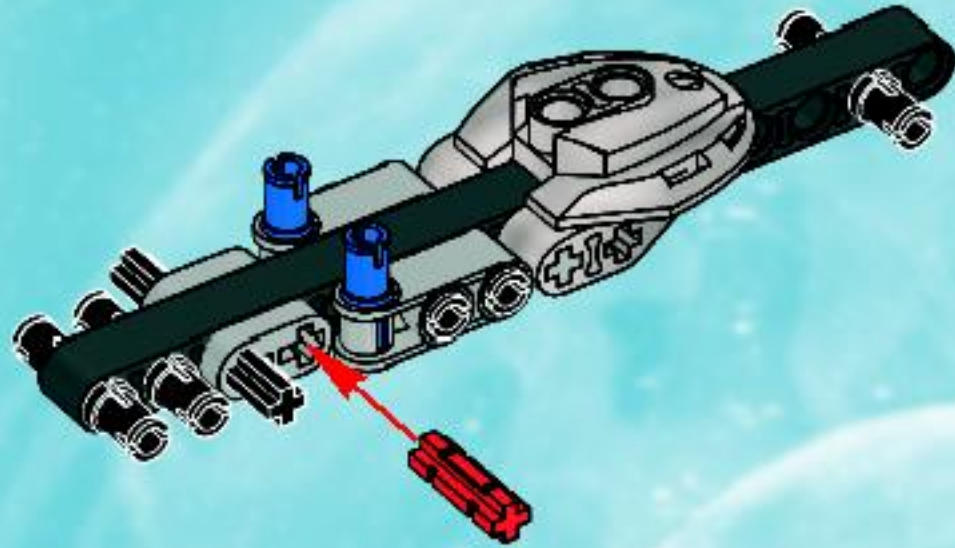





6

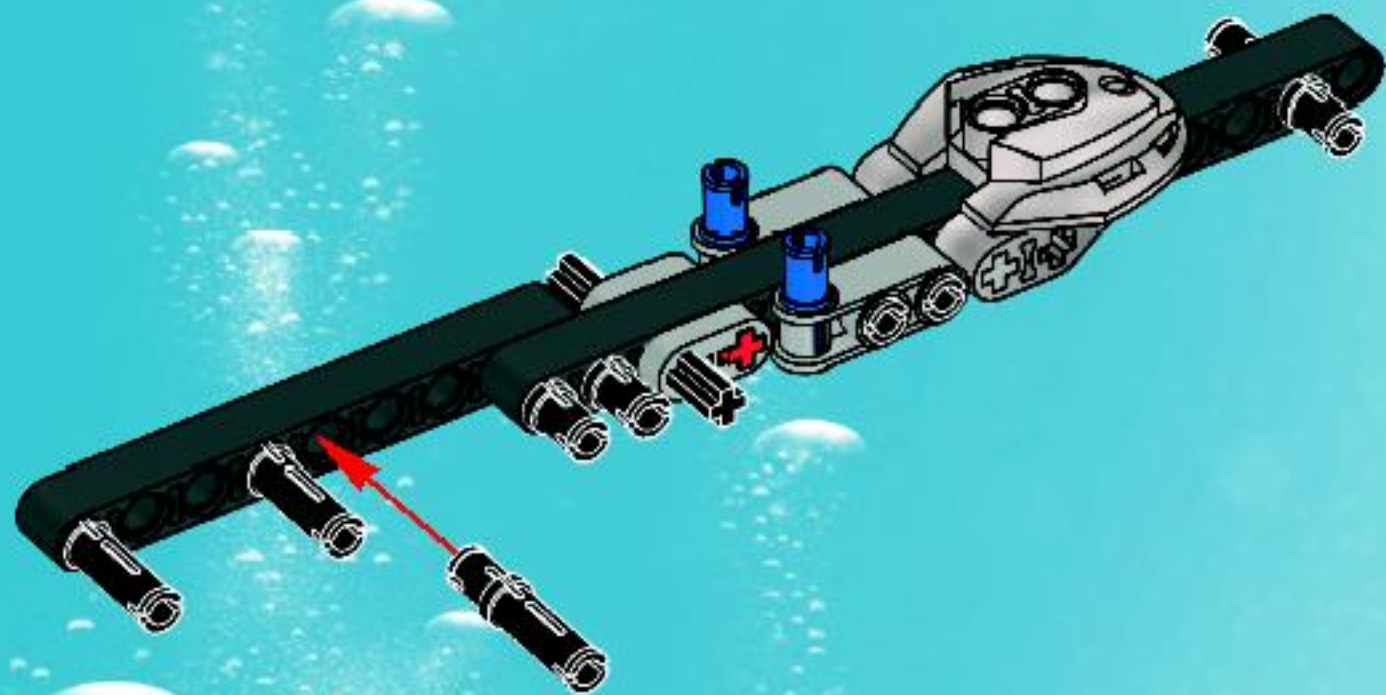



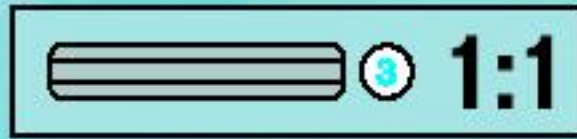
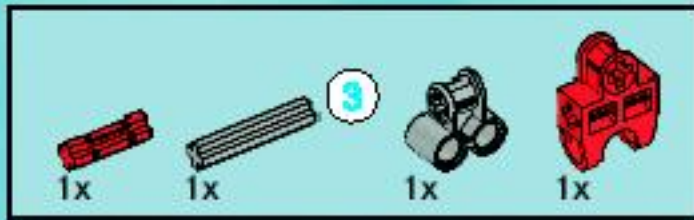

7

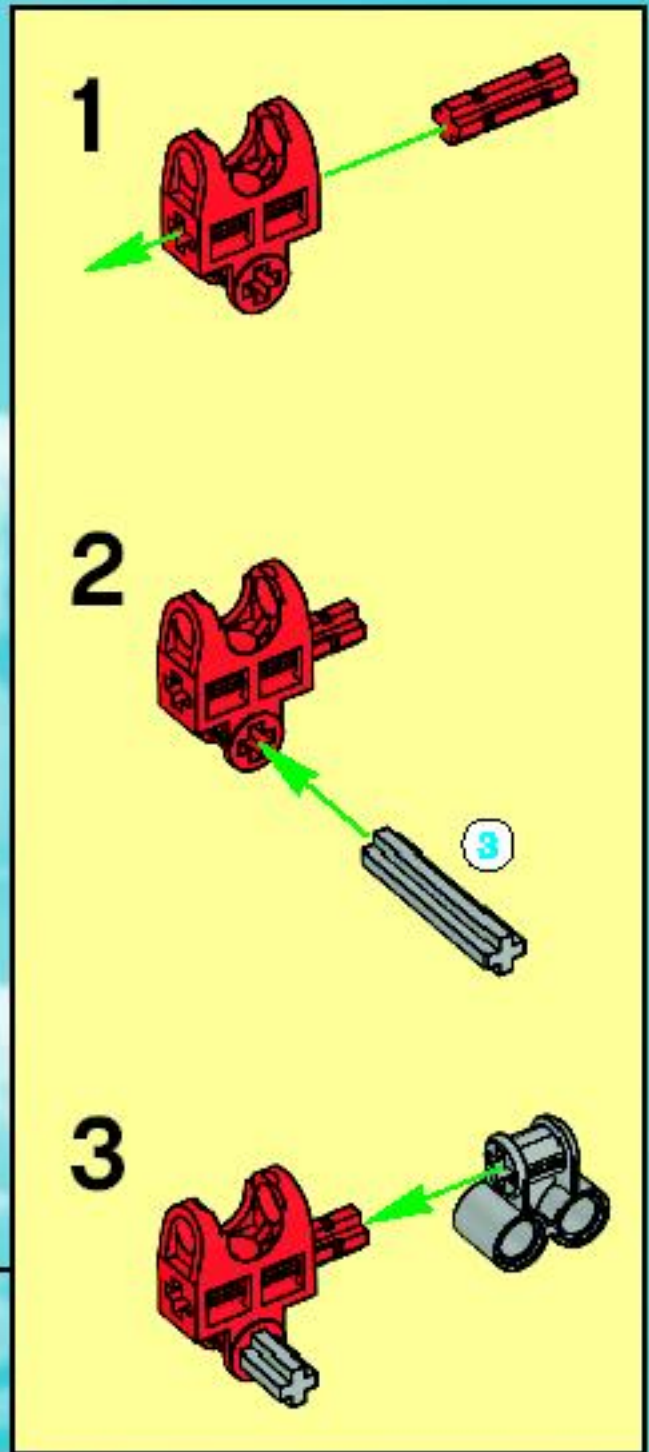
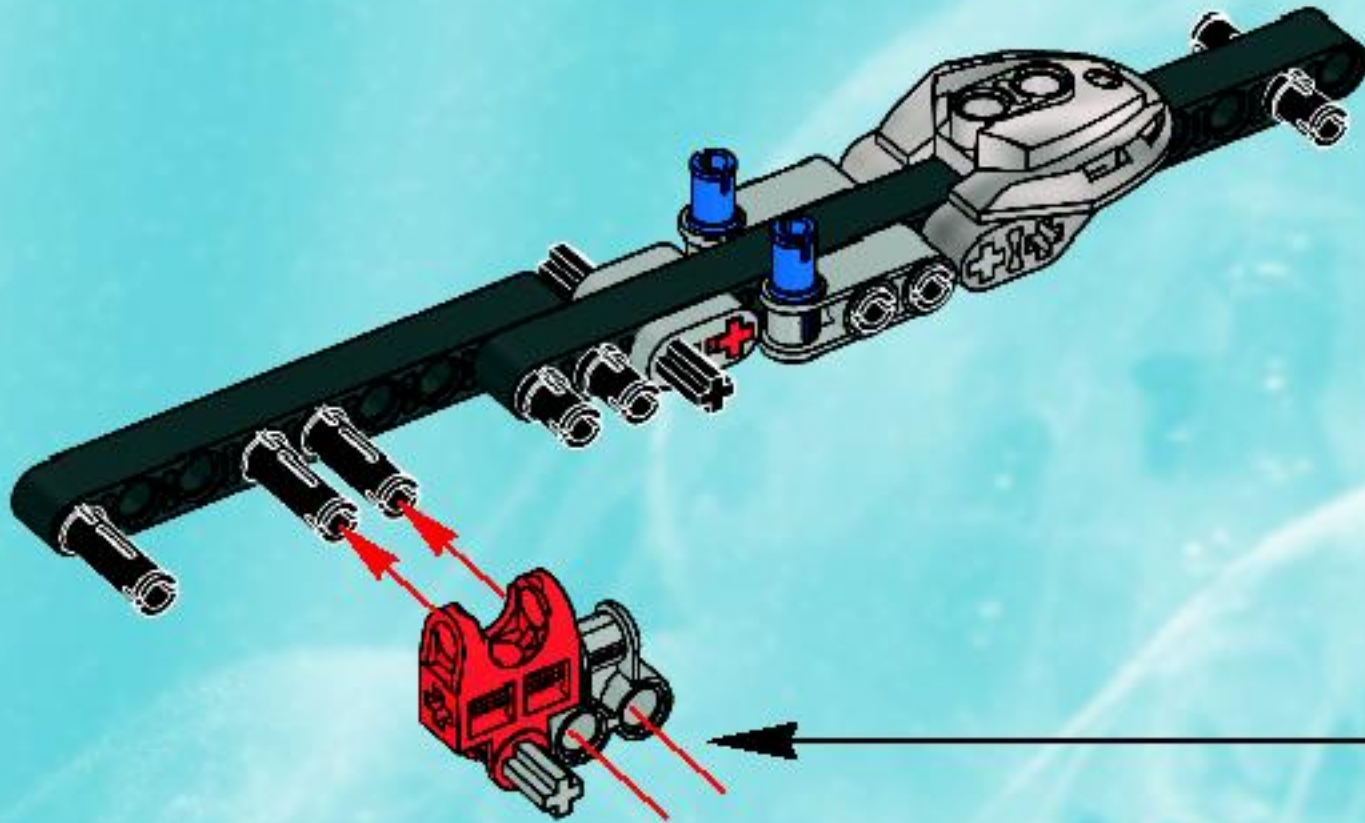



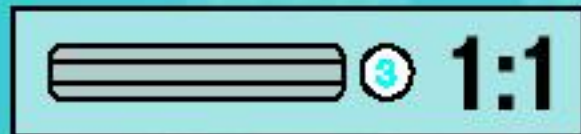

8

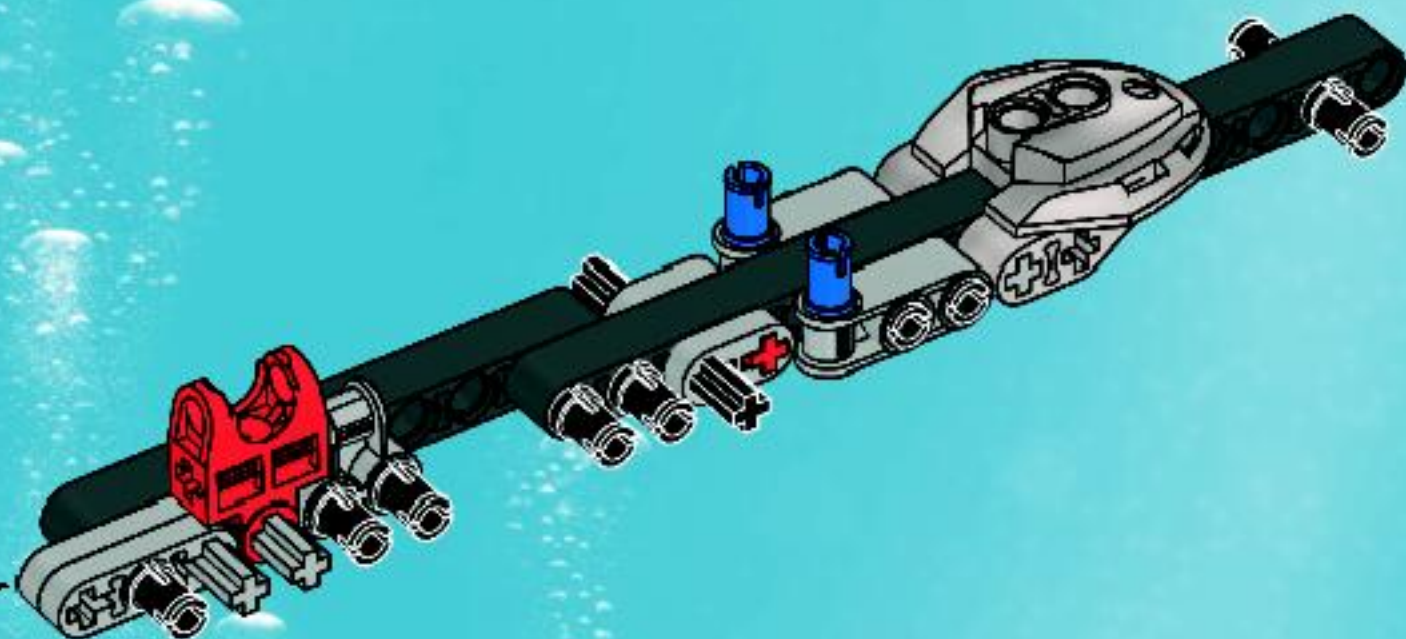
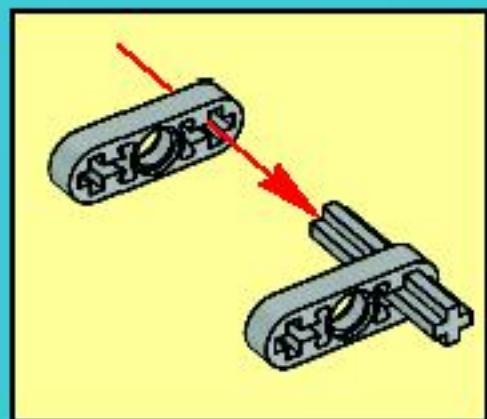



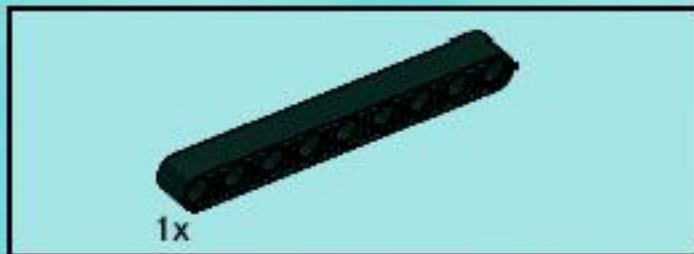

9

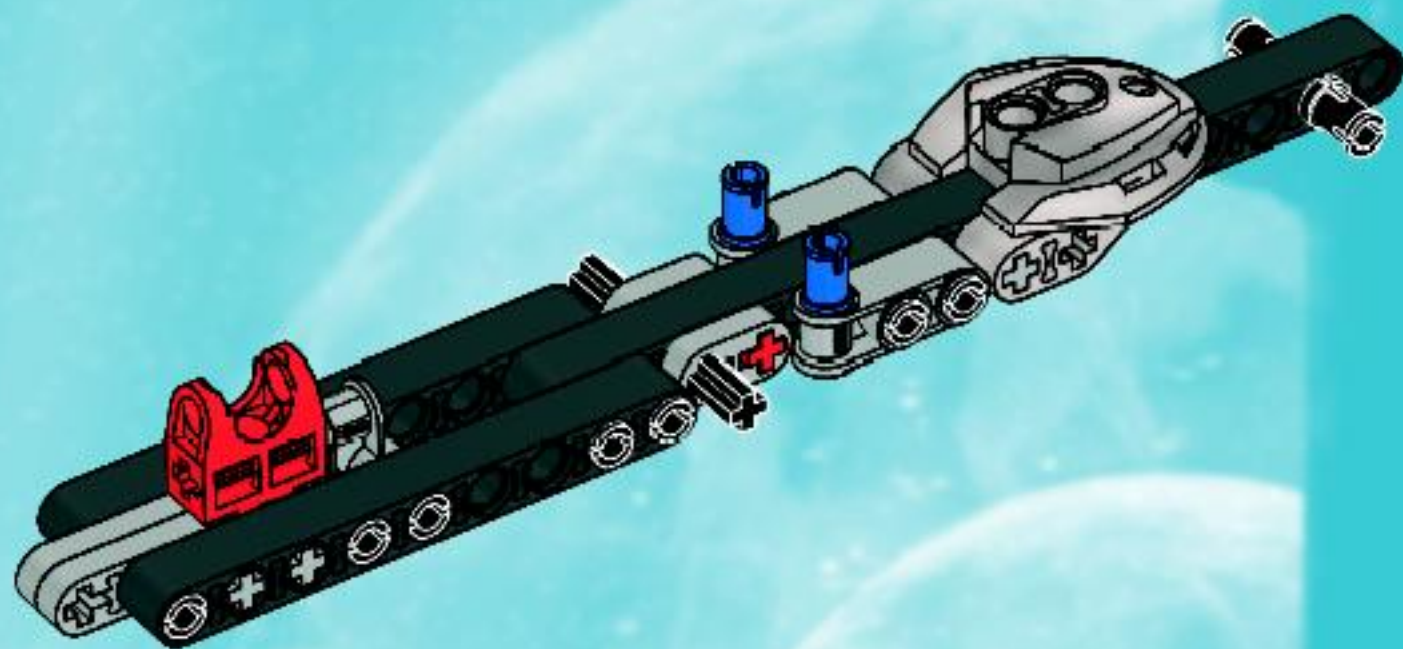





10

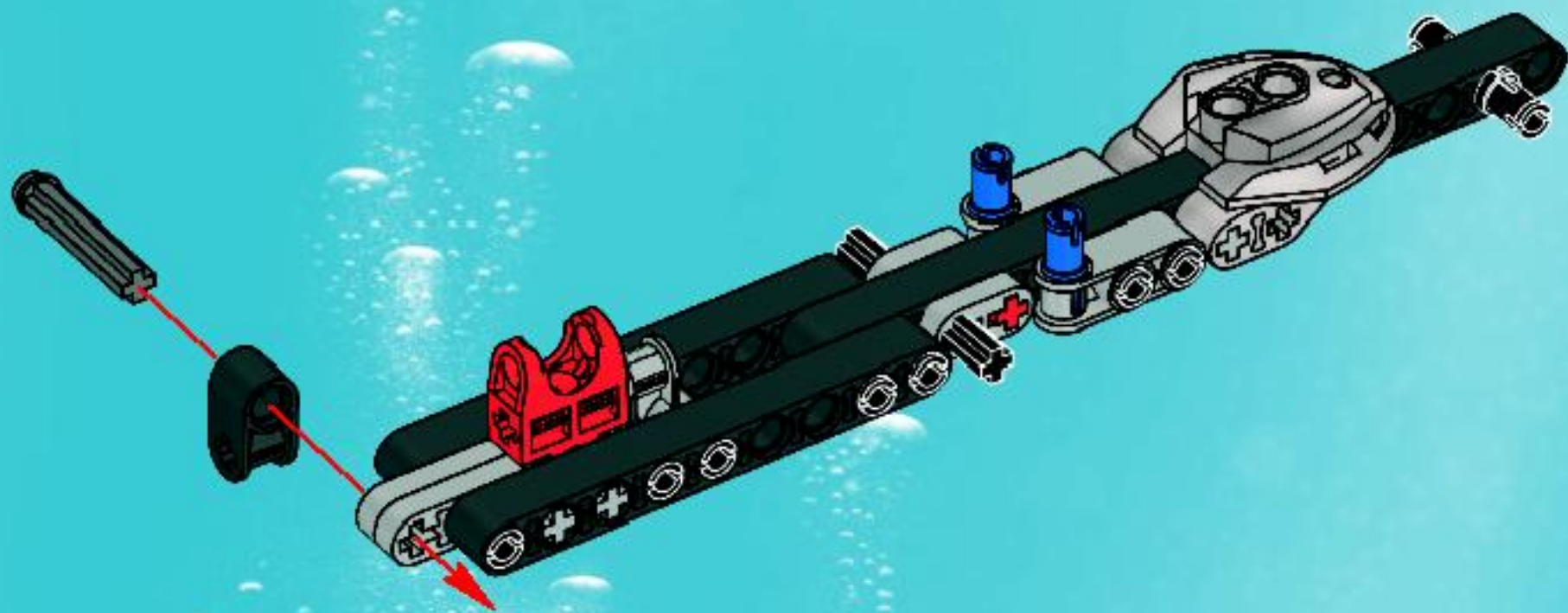

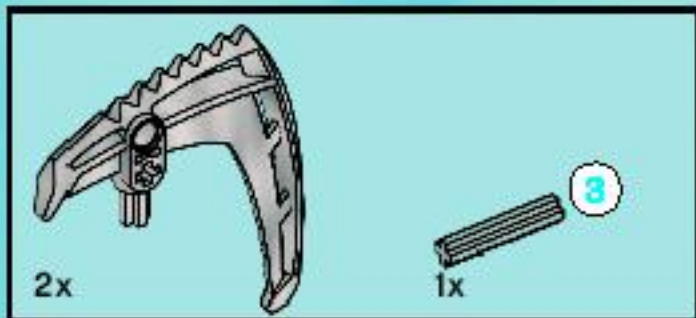

# 11

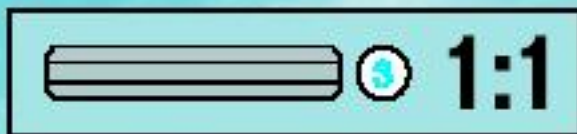
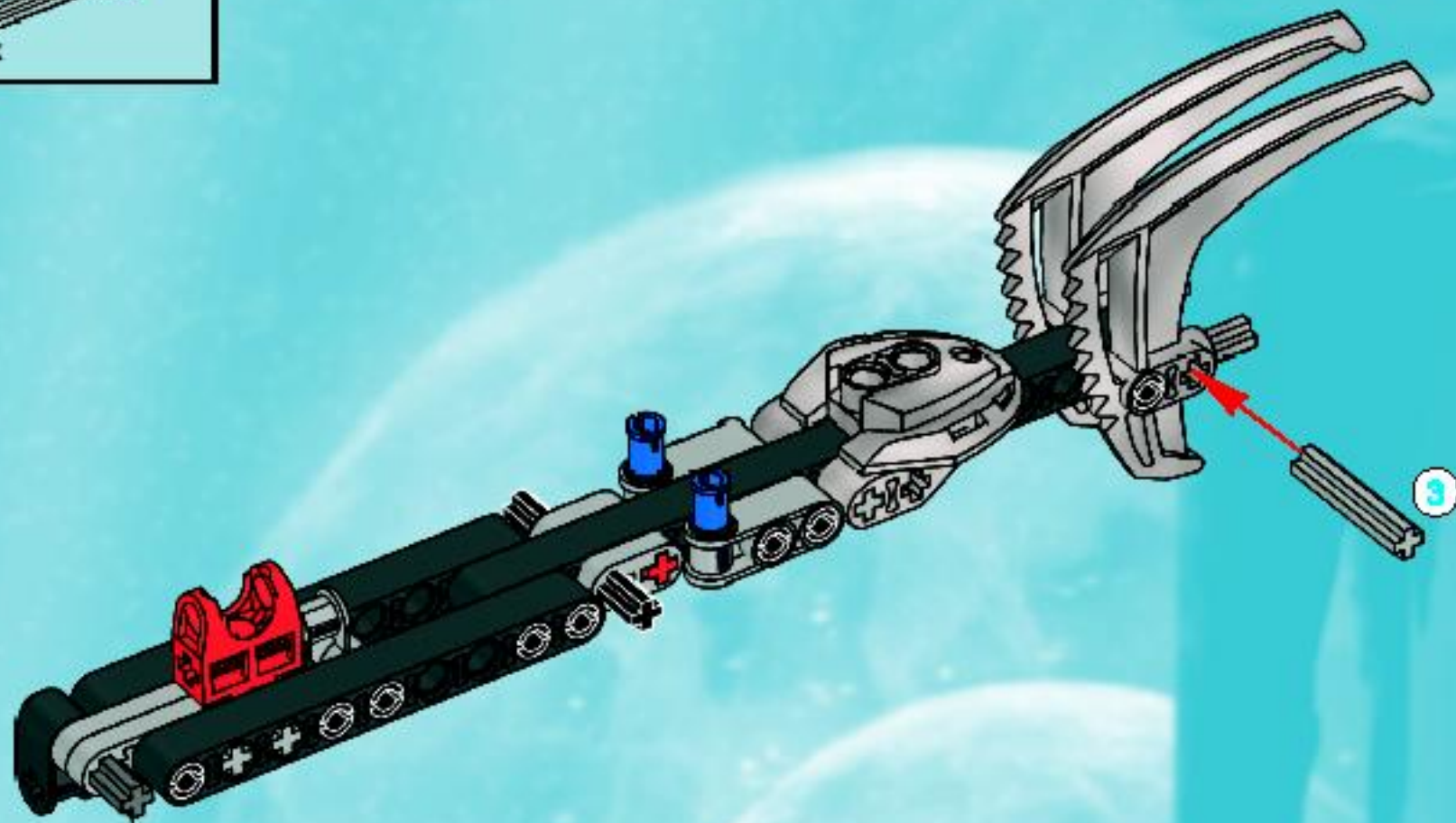





12

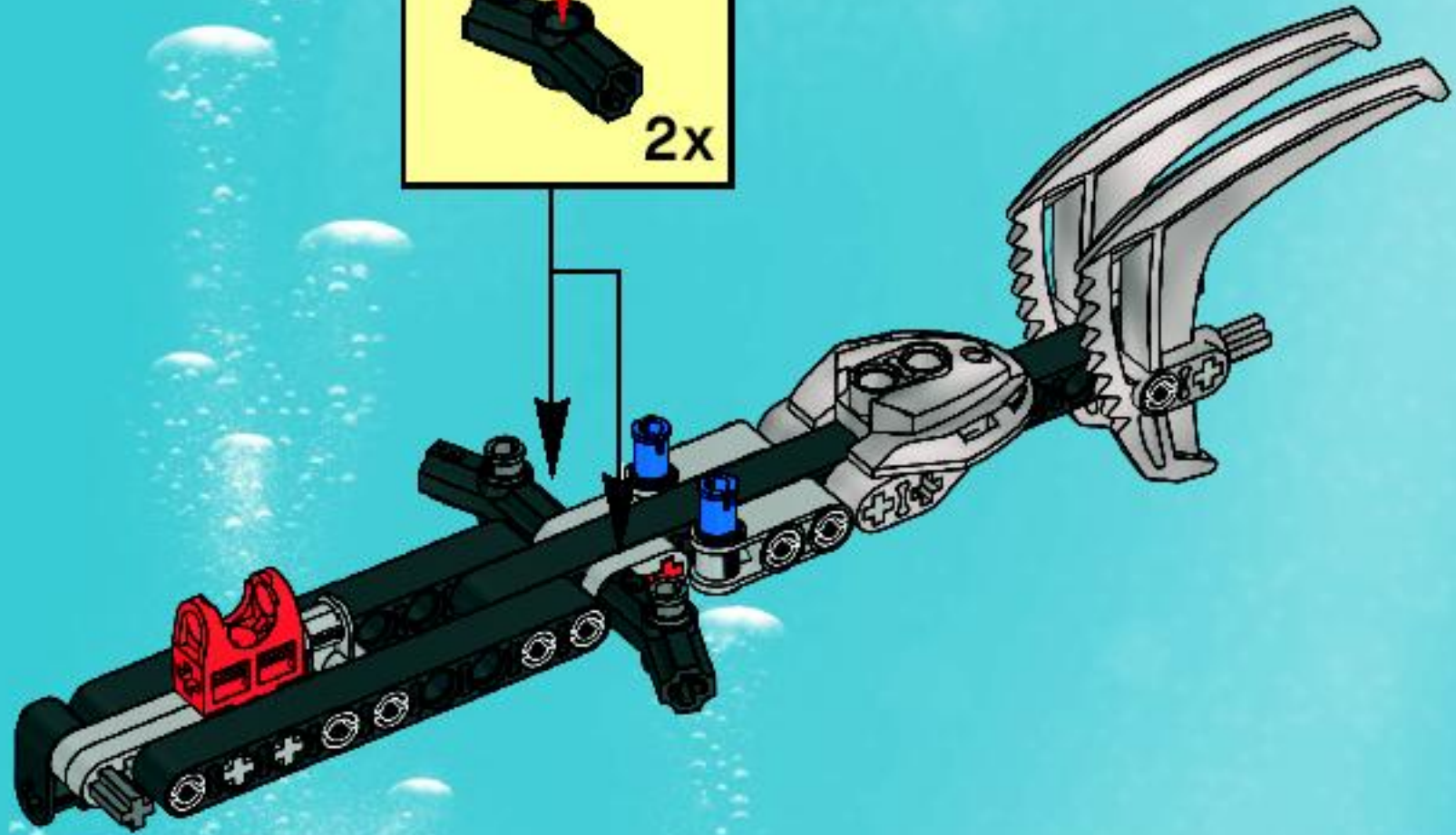
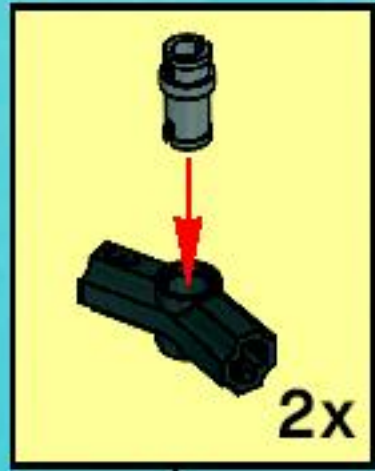

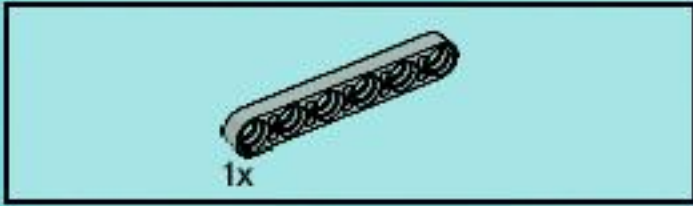

13

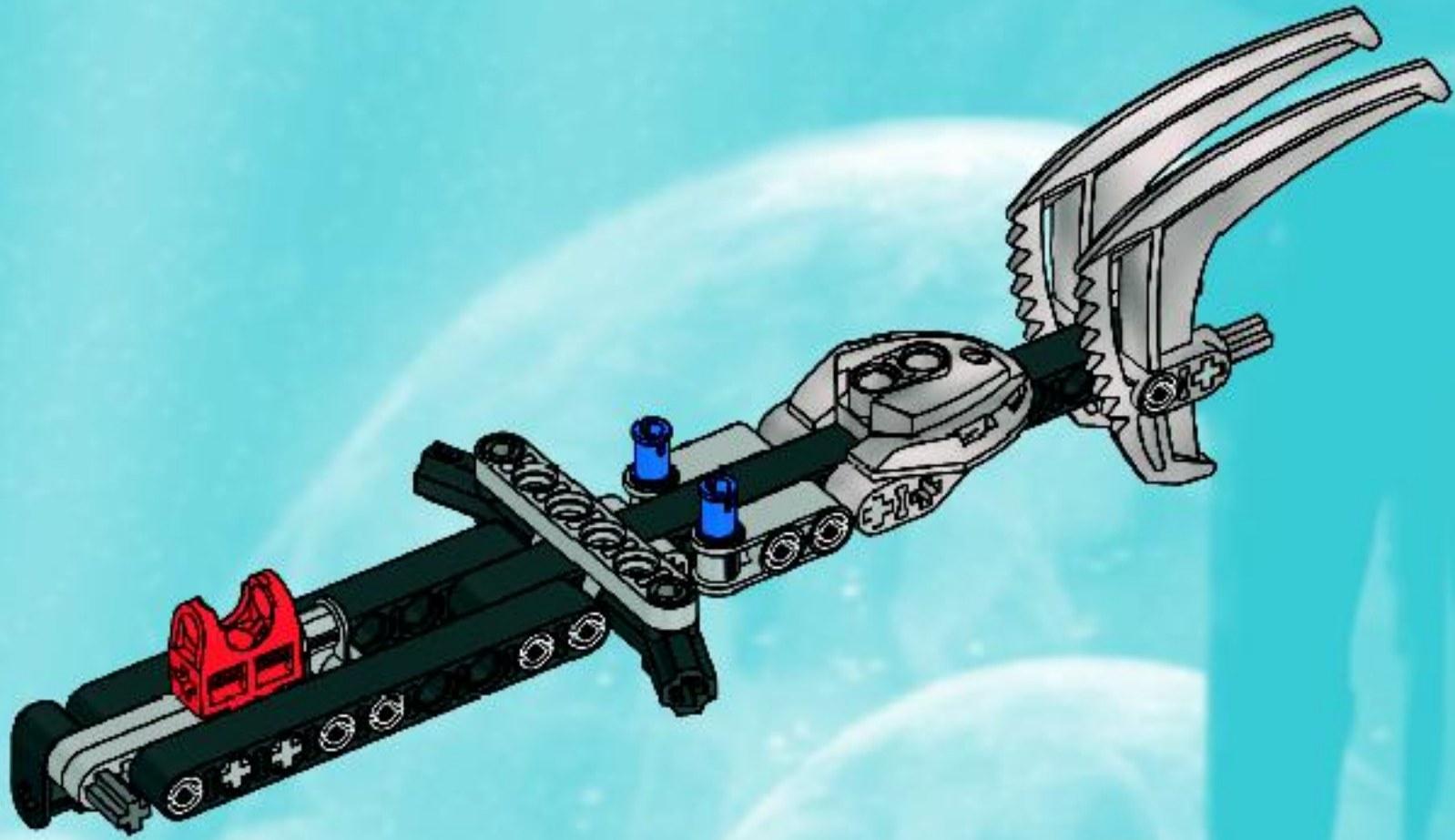





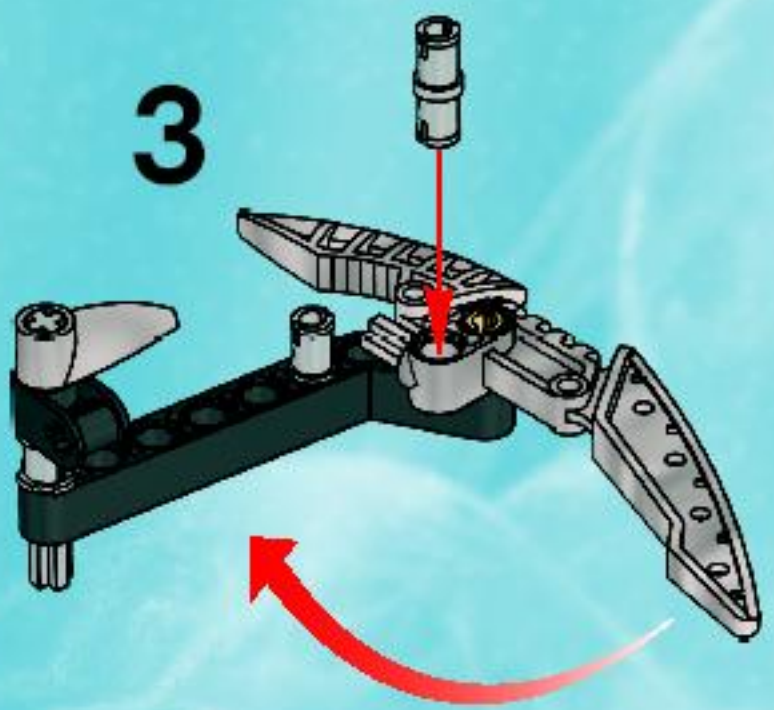
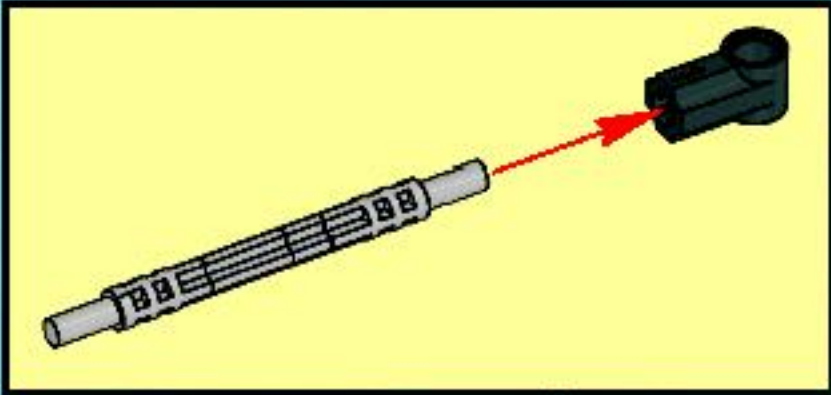

**4**

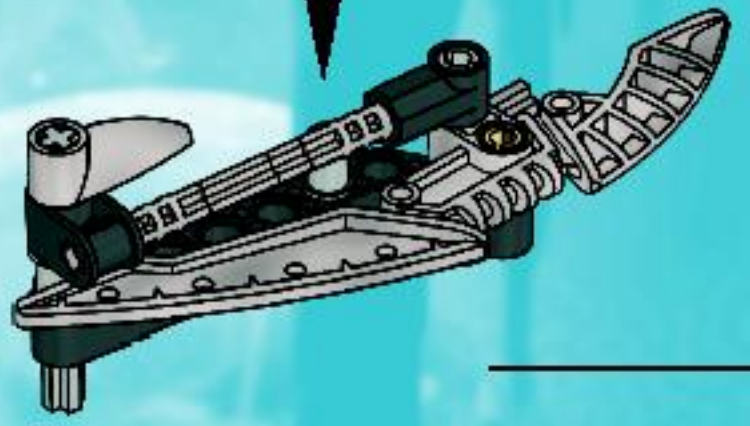



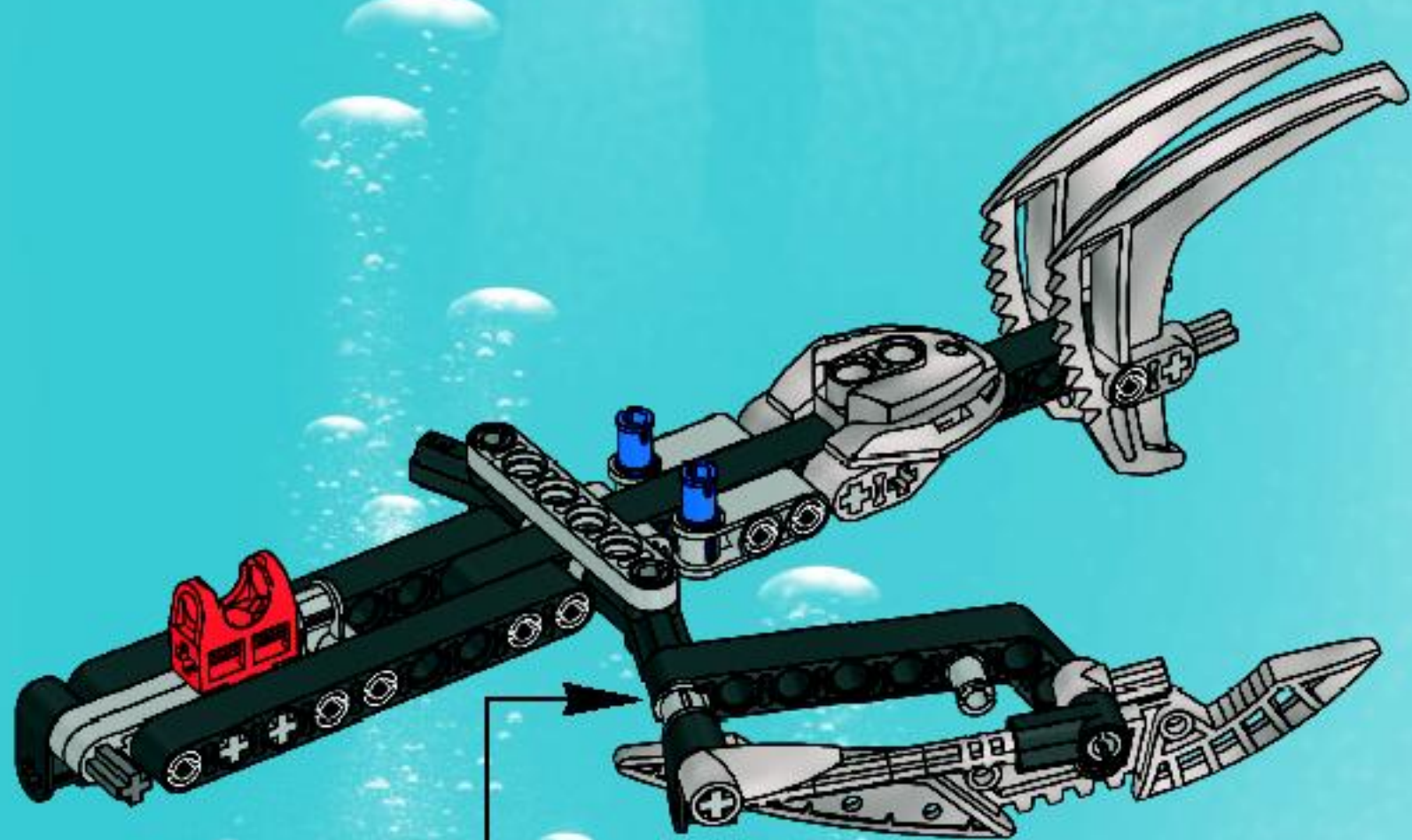





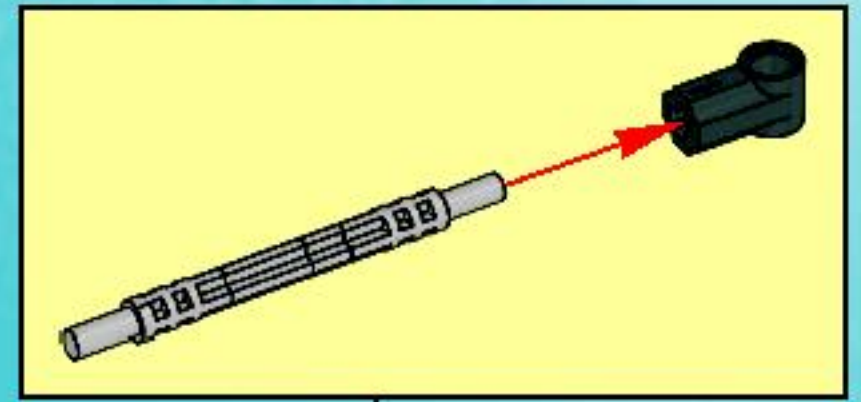
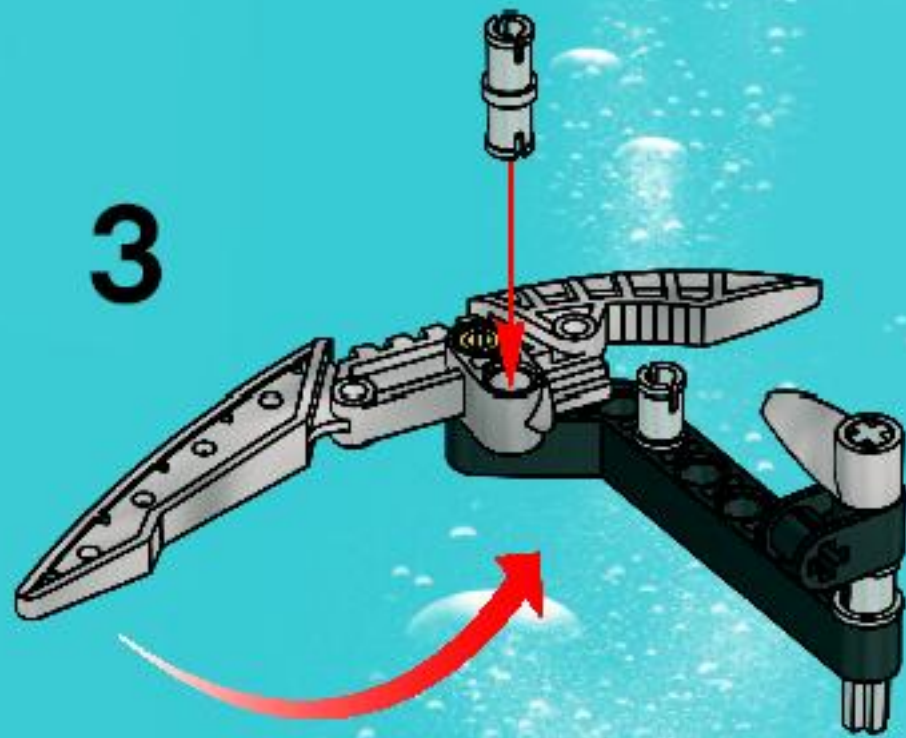

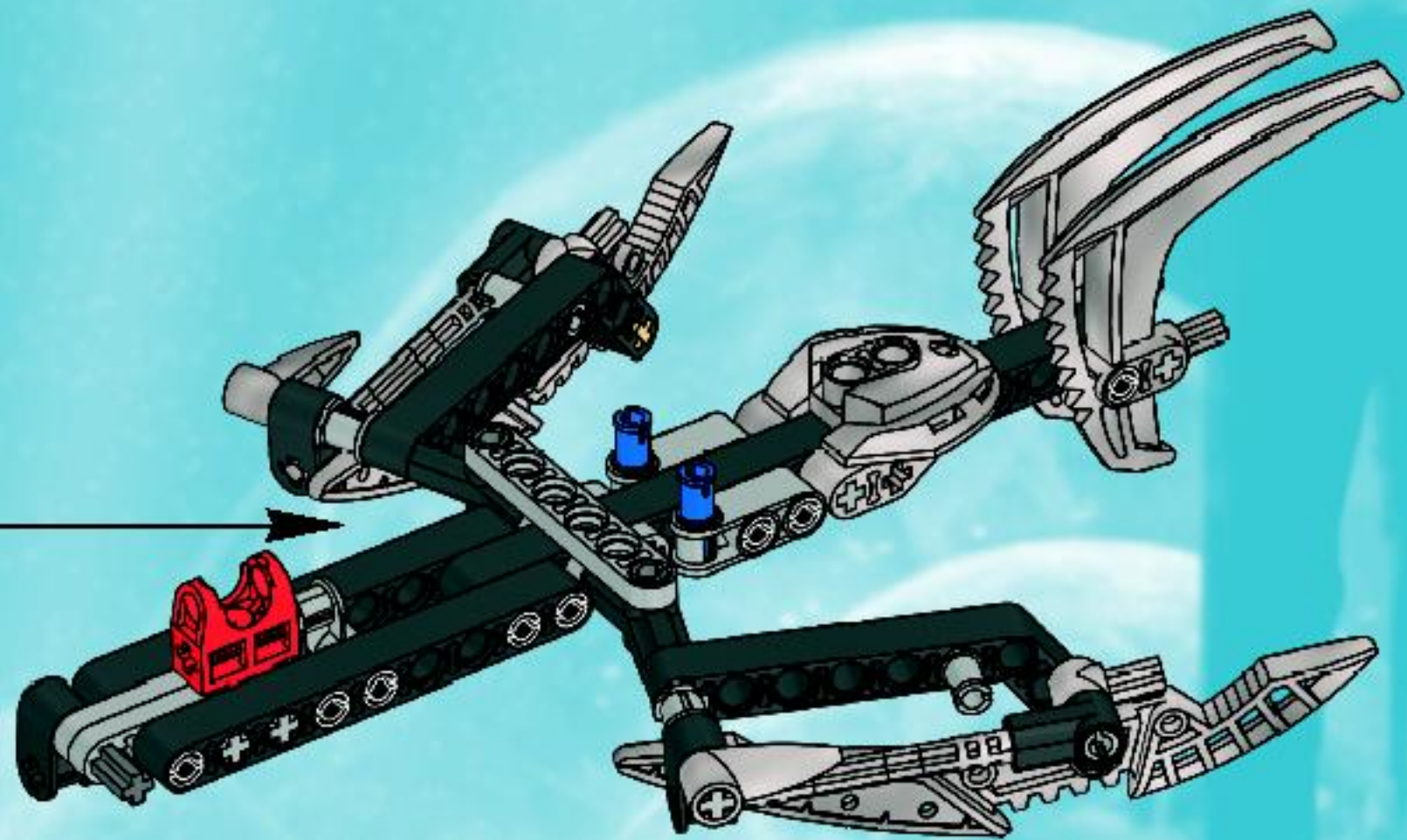



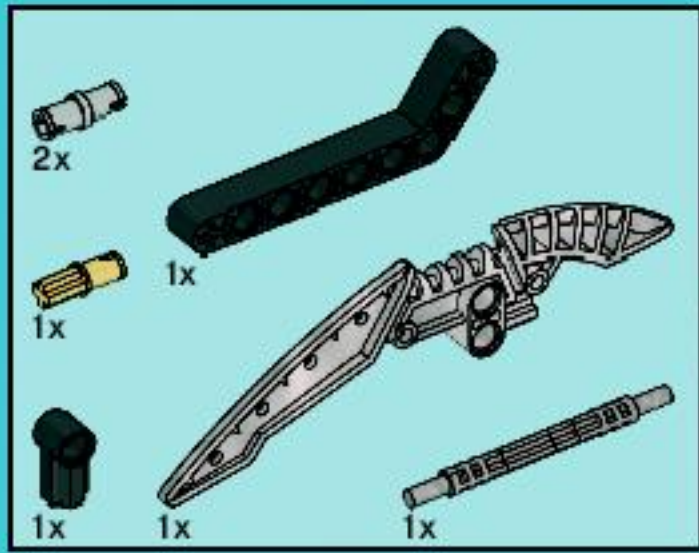

16

1

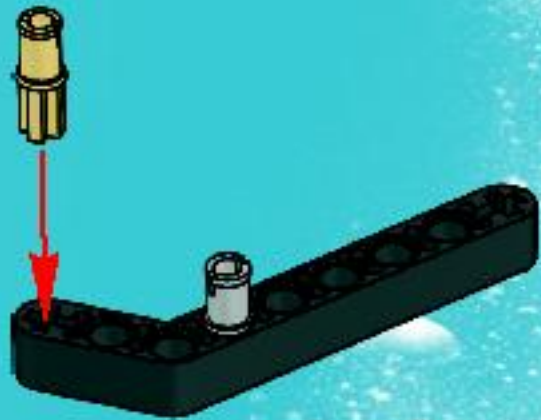

2

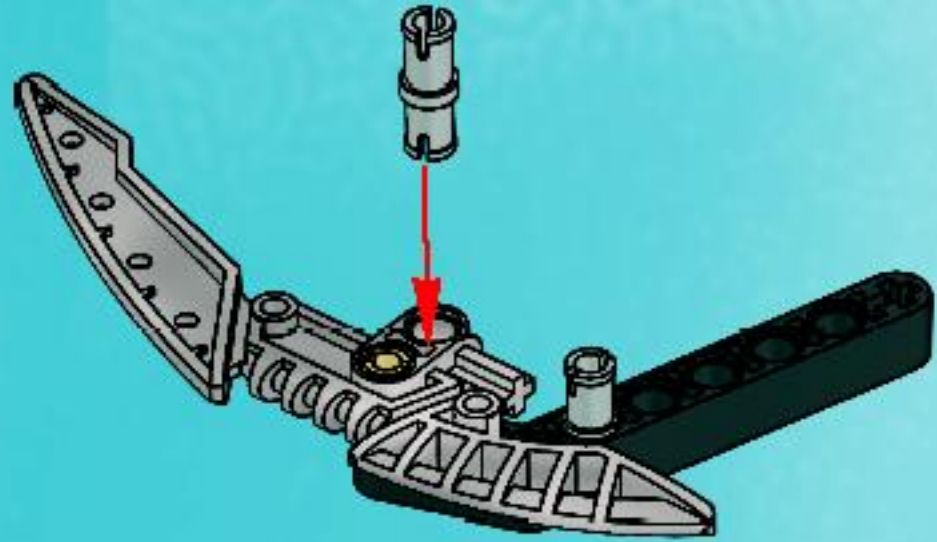

3

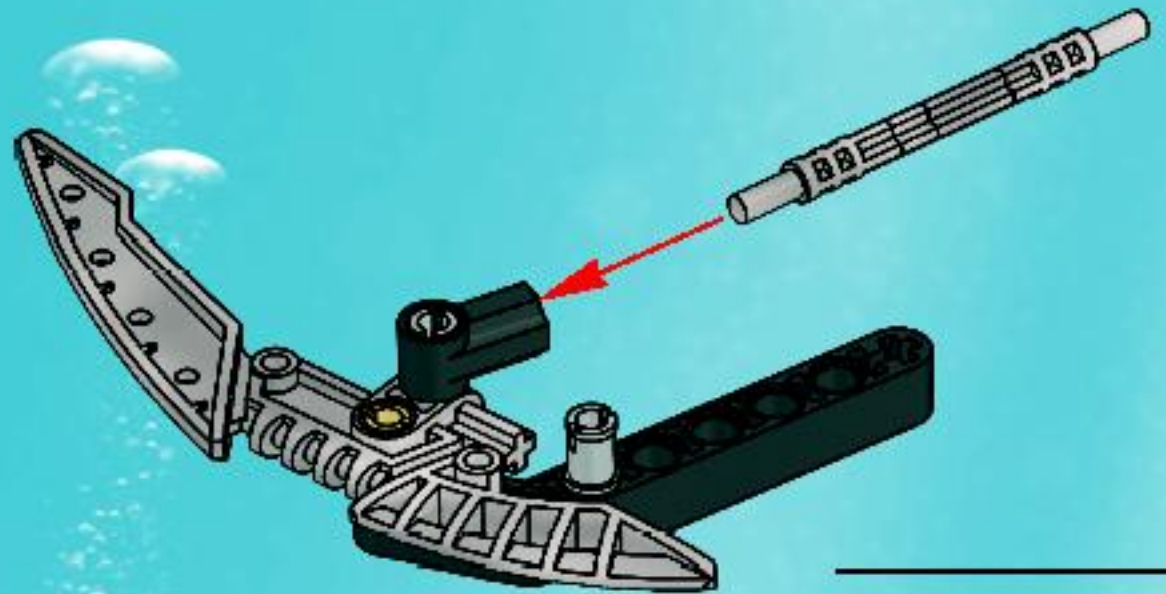

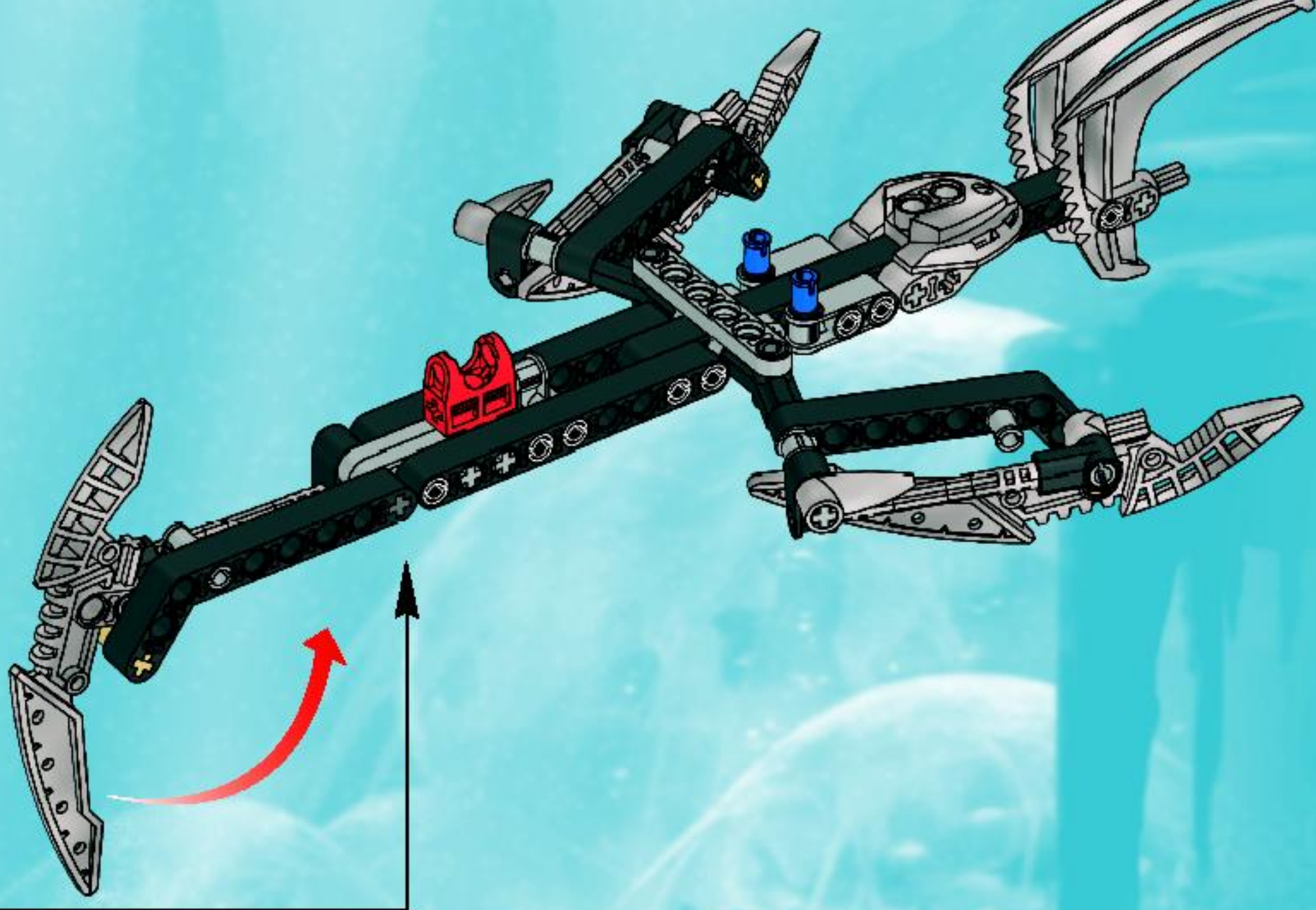



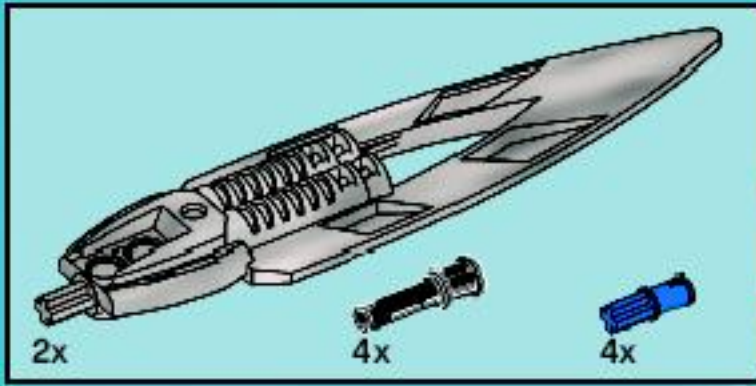

17

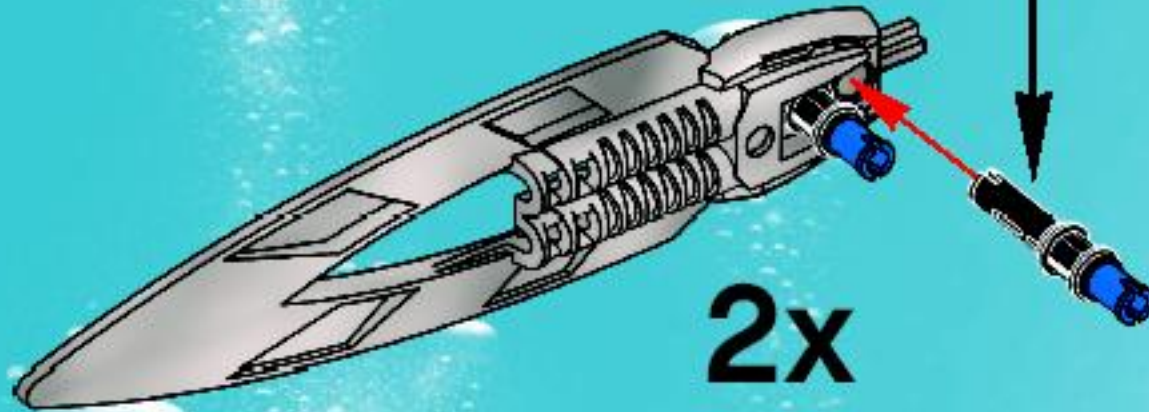
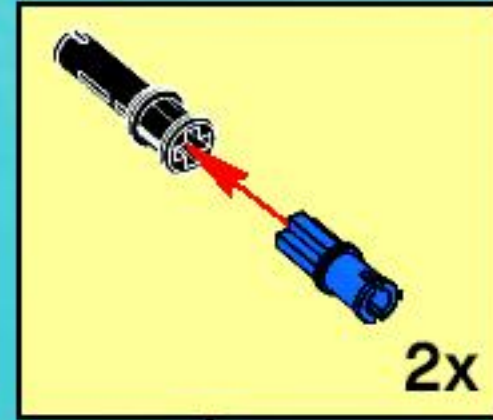

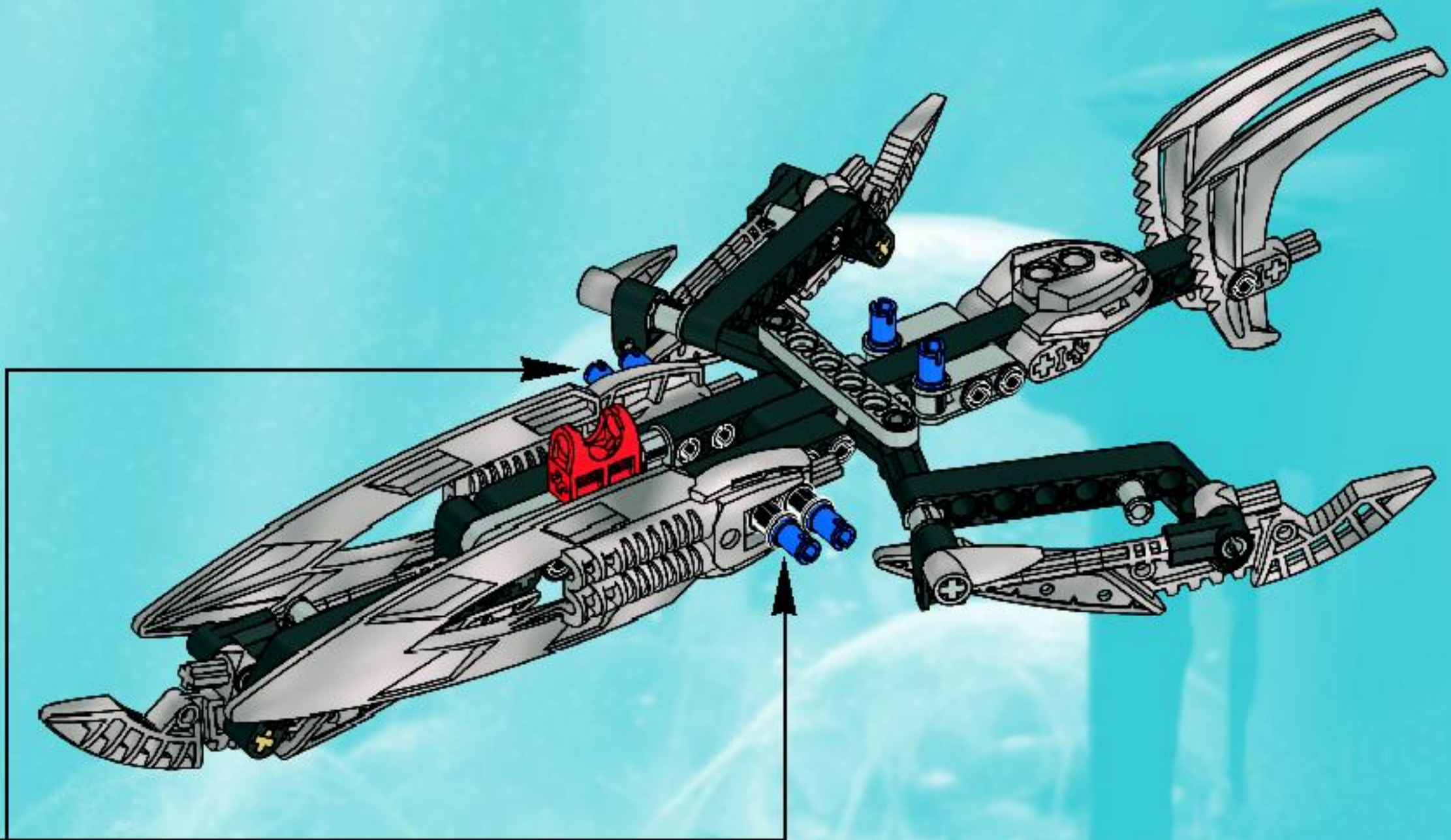



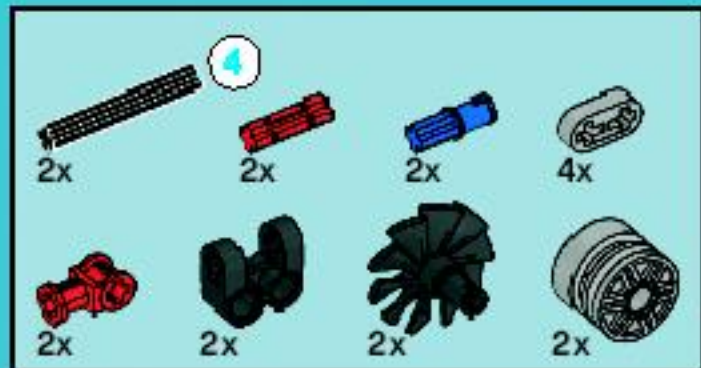

18

1



2



4

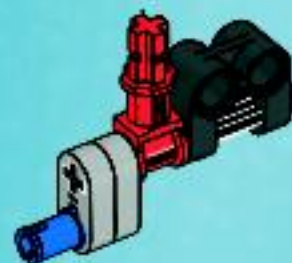

3



5

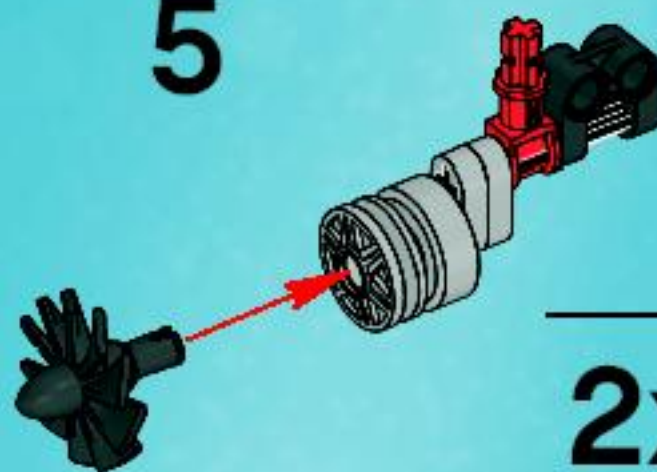

2x



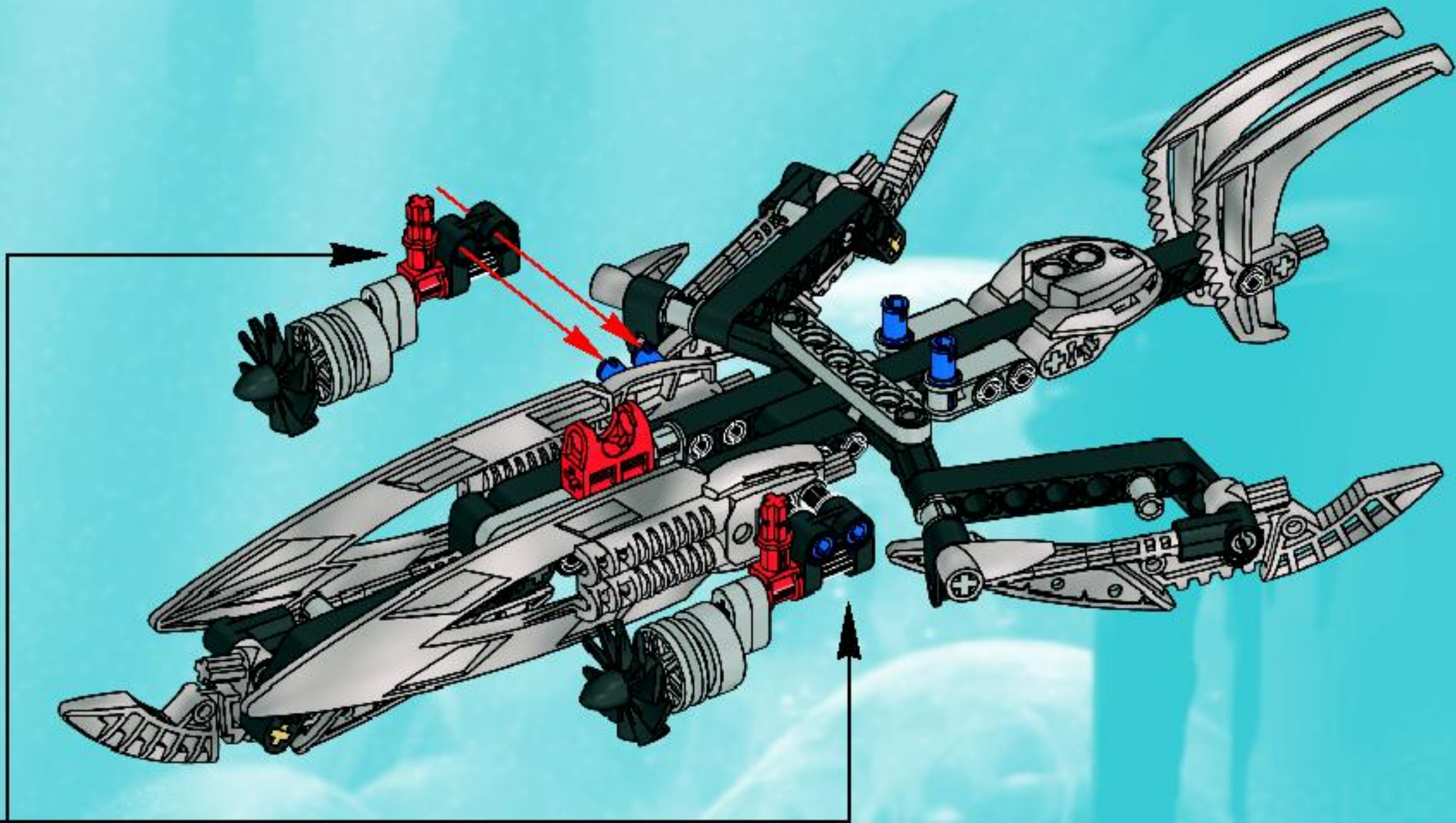



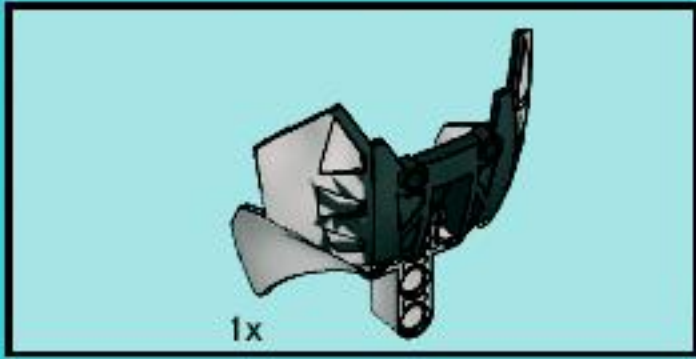

19

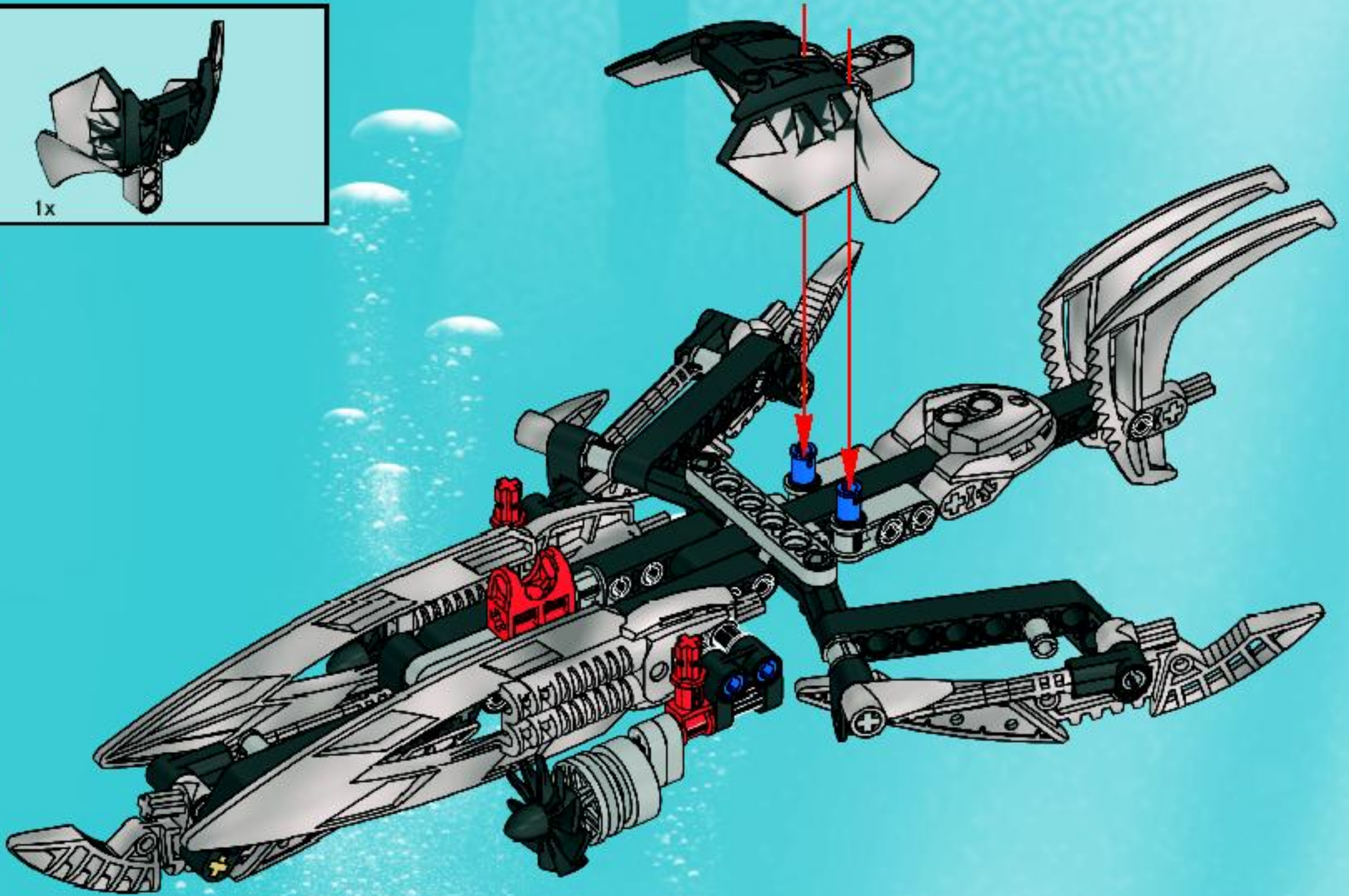





20

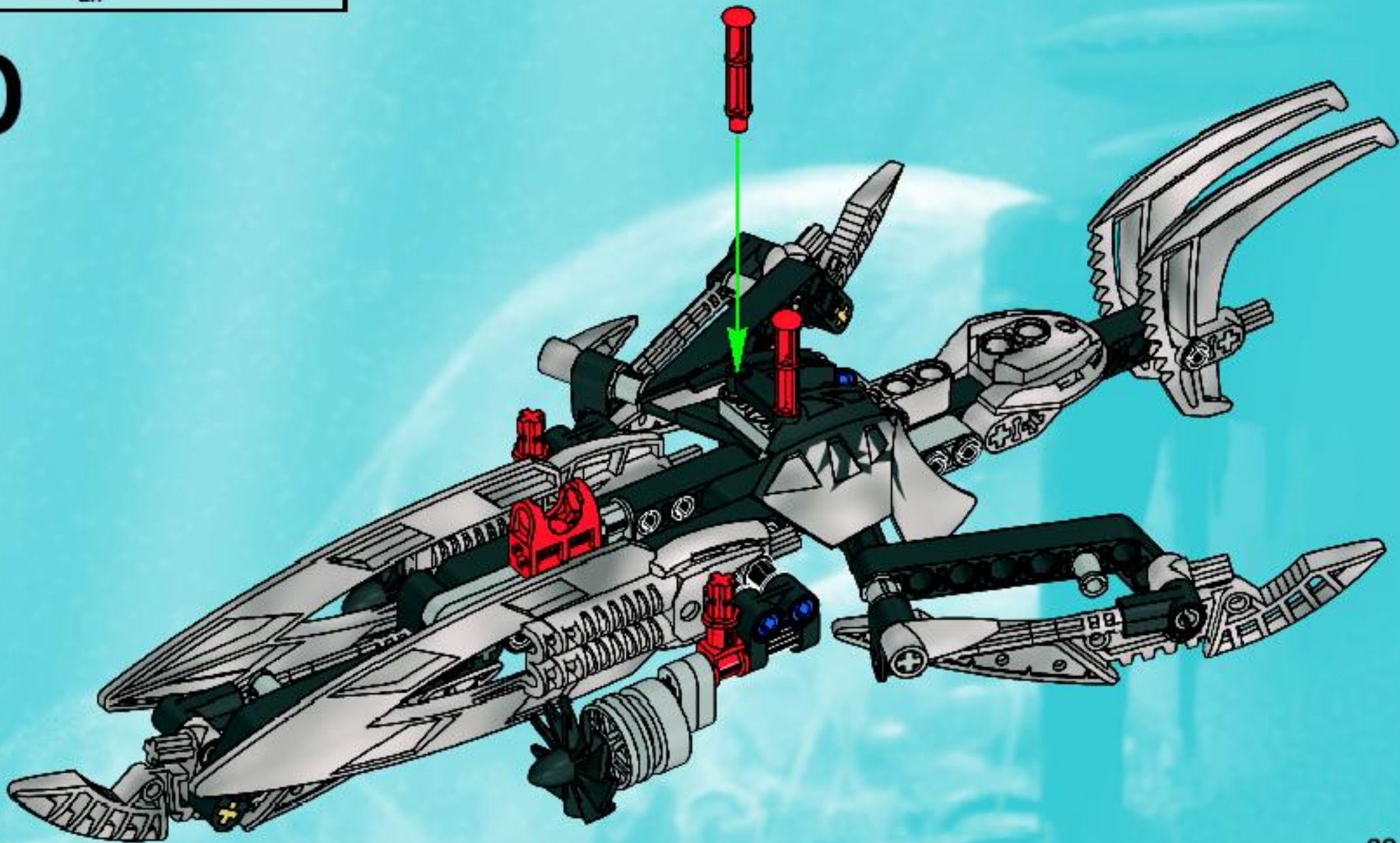



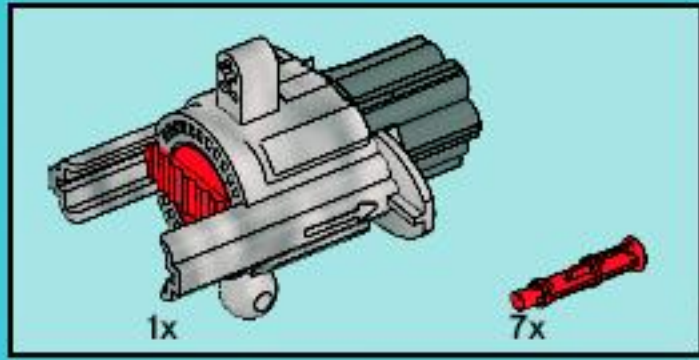

21

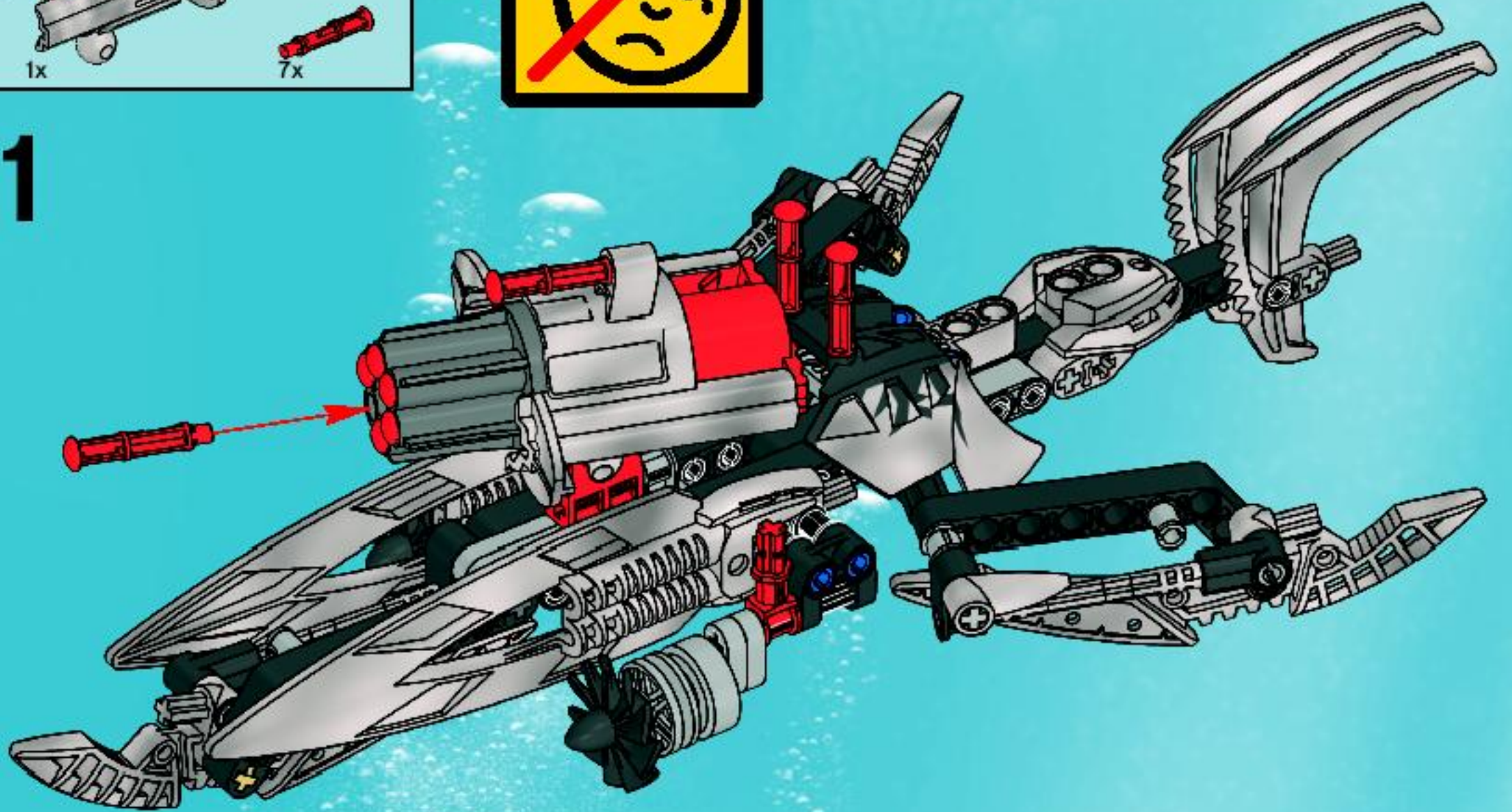



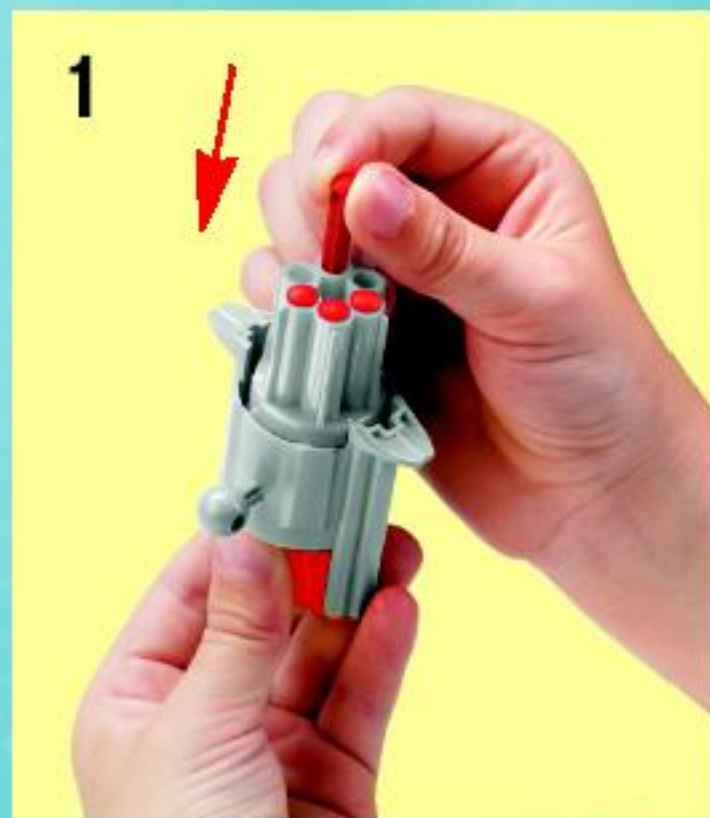



22

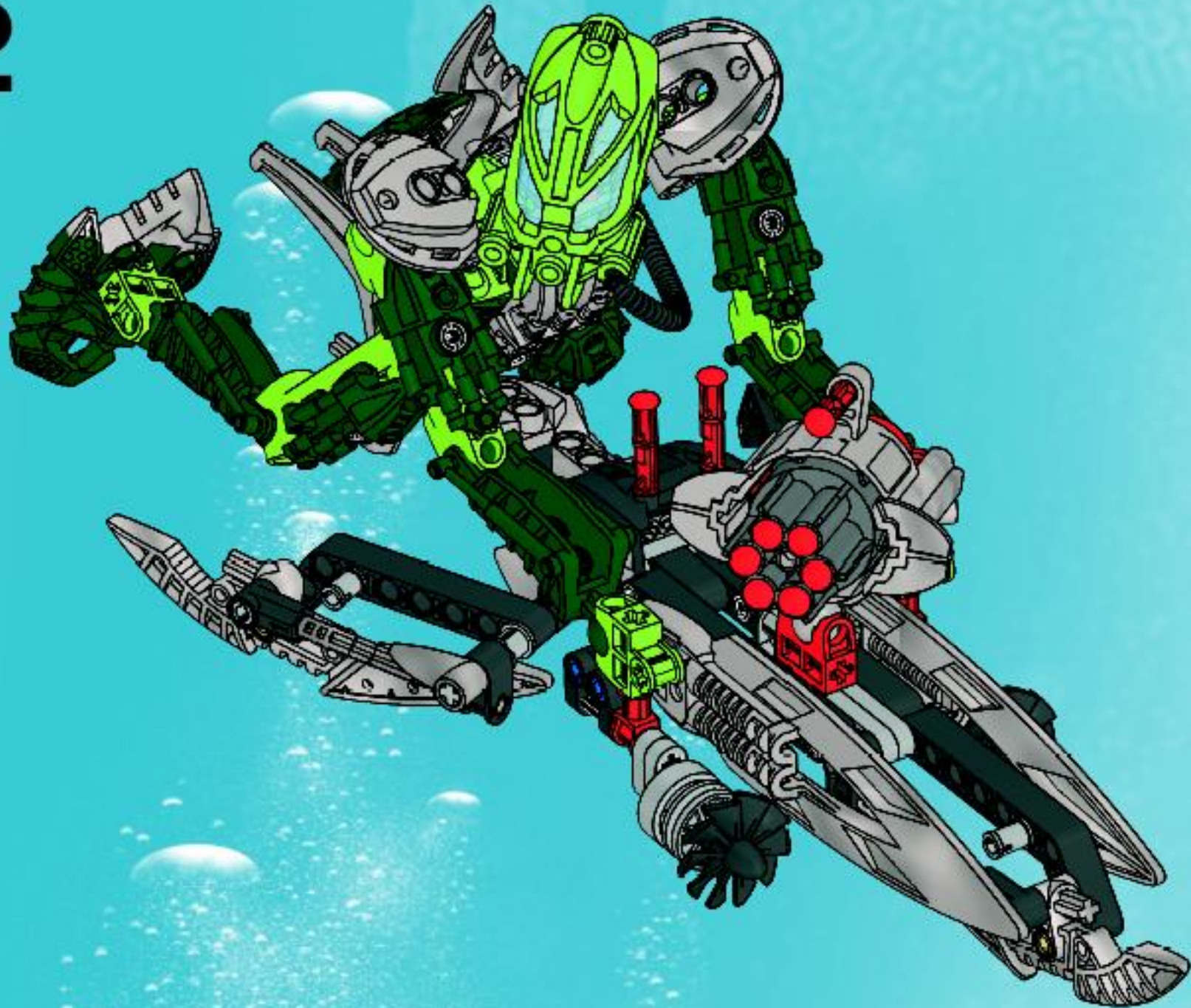



5x  
4142865

9x  
4497796

2x  
4118897

1x  
4119331

5x  
4140801

7x  
4121715

8x  
655826

3x  
370526

1x  
4504612

2x  
4288241

2x  
4162857

3x  
4107085

2x  
4107082

3x  
4173668

3x  
4140327

2x  
4154767

1x  
4128603

1x  
4505821

5x  
4256622

1x  
4284542

1x  
4513212

4x  
4252625

1x  
4288205

1x  
4278501

4x  
4501150

4x  
4276542

2x  
4493393

1x  
4504505

4



3x  
4186017

6x  
4211807

6x  
4211741

3x  
4504986



10x  
4206482

2x  
4211622

2x  
4211566

2x  
4211050

6x  
4211815 **3**

1x  
4211586

1x  
4505473

1x  
4211086

2x  
4211639 **5**

2x  
4211779

3x  
4195028

2x  
4497147

1x  
4278473

3x  
4163389

1x  
4211629

1x  
4494055

2x  
4177440

2x  
4299119

1x  
4506662

2x  
4504538



# MAHRI

8915  
Toa Matoro



8911  
Toa Jaller



8913  
Toa Nuparu



8910  
Toa Kongu



8914  
Toa Hahli



8912  
Toa Hewkii





# Win! Gagne! 当たります Gewinne!

## Win LEGO products

We would like to know what you think about your new LEGO product. Log on to the web address below for further instructions.

## Gagne des produits LEGO

Nous aimerions savoir ce que tu penses de ton nouveau produit LEGO. Tu obtiendras davantage d'informations en visitant le site Internet indiqué ci-dessous.

## Gewinne LEGO produkte

Wir sind sehr an deiner Meinung über dein neues LEGO Produkt interessiert. Gehe einfach zu der unten angegebenen Webadresse – dort findest du weitere Informationen.

## Estimado usuario LEGO

Al contestar algunas preguntas en inglés, francés, alemán o japonés, en el sitio [www.acnielsen.aim.dk/lego](http://www.acnielsen.aim.dk/lego), podrás participar en el sorteo de algunos valiosos premios LEGO.

## Caro Consumidor da LEGO

Ao responder a algumas perguntas em Inglês, Francês, Alemão ou Japonês no endereço [www.acnielsen.aim.dk/lego](http://www.acnielsen.aim.dk/lego) irá participar num concurso para ganhar valiosos prémios da LEGO.

## Kedves ifjú LEGO Vásárló

Ha ellátogatsz a [www.acnielsen.aim.dk/lego](http://www.acnielsen.aim.dk/lego) honlapra és ott angol, francia, német vagy japán nyelven megválaszolsz néhány kérdést, akkor részt veszel egy versenyben, amelyben értékes LEGO díjakat nyerhetsz.

## 抽選でレゴ製品が当たります

私たちは、皆さんが買い求めたレゴ製品についてどんな感想をお持ちか、知りたいと思っています。質問に答えて、楽しいレゴ製品の抽選に応募していただく。アンケートの回答には、ほんのわずかなしかかりません！詳しくは、以下のウェブアドレスまでアクセスしてください。

[www.acnielsen.aim.dk/LEGO](http://www.acnielsen.aim.dk/LEGO)



Any questions regarding your new LEGO product, please contact:  
Customer Service | Kundenservice | Service Consommateurs  
Servicio Al Consumidor at [www.lego.com/service](http://www.lego.com/service) or dial

 :

00800 5346 5555

 :

1-800-422-5346







# club™

FREE LEGO Magazine • GRATUIT • GRATIS LEGO Magazin



**Join Today!**  
**Abonne-toi dès aujourd'hui !**  
**Meld je nu aan!**  
**Jetzt anmelden!**

  US & Canada only

1-866-534-6258 / 1-877-518-5346  
(en français)

00800 5346 5555      

[www.LEGOclub.com](http://www.LEGOclub.com)



VISIT THE  
**WORLD'S BIGGEST  
LEGO® SHOP!**  
[www.LEGOshop.com](http://www.LEGOshop.com)



# WWW.BIONICLE.COM



## BIONICLE

START STORY PRODUCTS FUN ZONE KNOWLEDGE + MESSAGE BOARDS

### BARRAKI

PLAY MOVIE

### BARRAKI LOG

Among the most magnificent warriors, a few warriors have taken, gathered, and mastered...

#### NEW PRODUCTS

Headless and armless, the Barraki trade what they want and stop it nothing to gain. Jan is the questor for the Mask of Life. [BARRAKI](#)

#### NEW GAME

Escape the evil creature from the cave. This is a battle of escape.

#### GALLERY MODELS

What are the models? What are the models? What are the models?

#### WHAT'S NEW

What are the models? What are the models? What are the models?

